

NARDI
YOUR OUTDOOR LIVING

contract

contract
design Raffaello Galotto

Arredi per l'outdoor in resina fiber-glass studiati per il well-being delle persone.

Design, studio dei colori, eccellenza produttiva totalmente Made in Italy. Attenzione all'ambiente nei cicli industriali, nella riciclabilità dei prodotti e riutilizzo degli scarti, nell'ideazione di packaging eco-compatibili. Ampia gamma di prodotti, misure e colori disponibili a catalogo per arredi apprezzati dai progettisti di tutto il mondo.

Outdoor furnishings in fiberglass resin designed for people's well-being.

We bring together unique designs with the study of colours, the manufacturing excellence of a product entirely created Made in Italy. Great attention to the environment when it comes to the industrial cycles, recycling products, reusing scraps and creating eco-compatible packaging. A wide range of products, sizes and colours available in the furnishing catalogue appreciated by project designers the world over.

komodo	7
trill	23
net bench	31
net relax	37
net	41
net table	49
bit	53
bora · riva · costa	57
acquamarina · darsena	67
lido · faro	73
aria · aria tavolino	79
palma · erica · gardenia · dalia	87
ninfea · loto	93
dama · regina · duca	99
cube	105
clip	109
step · spritz	113
fiore · ibisco	117
flute · break	123
scudo	127
atlantico · pop	131
alfa · omega	139
technical details	145

index

komodo

gardiente®
OUTDOOR
LIVING
AWARD
WINNER
2018
GOLD





KOMODO
tortora/rosa quarzo



KOMODO
tortora/rosa quarzo



KOMODO
tortora/rosa quarzo



KOMODO 5
tortora/rosa quarzo

KOMODO
Divano modulare/Modular sofa

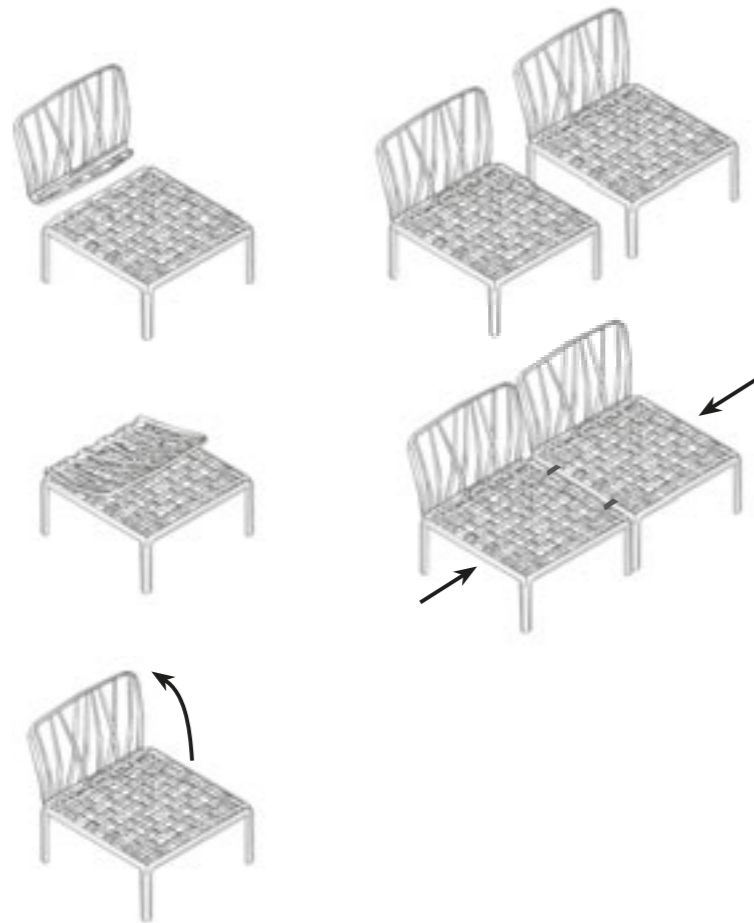

KOMODO
tortora/canvas



KOMODO
bianco/adriatic



KOMODO
bianco/adriatic



KOMODO
antracite/grigio
KOMODO TAVOLINO
antracite



KOMODO TAVOLINO
antracite





KOMODO POUF
 bianco - antracite - tortora
CUSCINI SEDUTA
 rosa quarzo - adriatic - canvas - grigio



KOMODO POUF
 bianco
CUSCINI SEDUTA
 canvas



KOMODO WALL
tortora

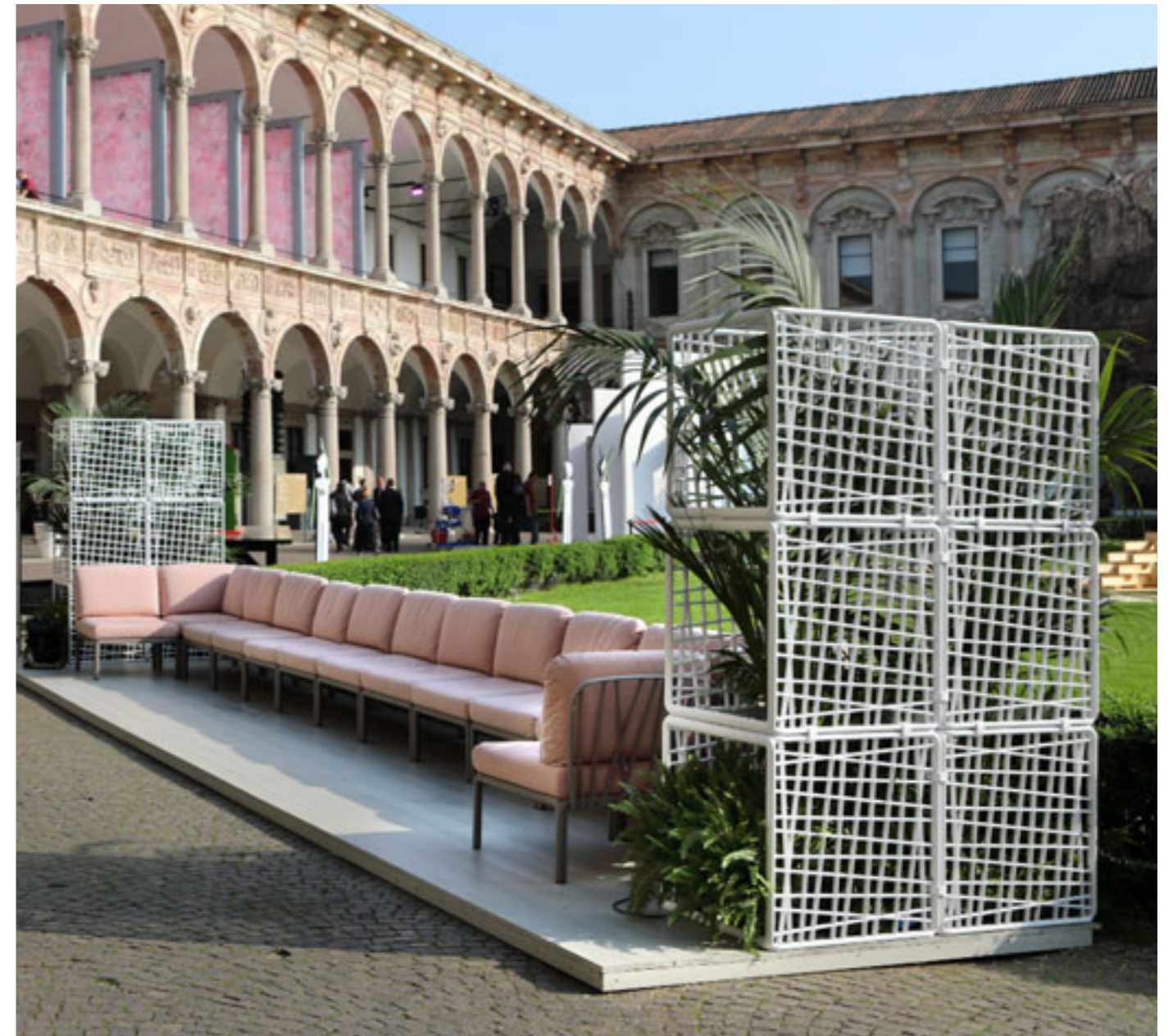

trill





TRILL ARMCHAIR
tortora



TRILL ARMCHAIR
senape



TRILL ARMCHAIR
senape



TRILL BISTROT
ottanio



TRILL BISTROT
ottanio
FIORE 70x70
bianco



TRILL BISTROT
bianco

TRILL STOOL
agave



TRILL STOOL
tabacco
FIORE HIGH
bianco



TRILL STOOL
agave
TRILL STOOL MINI
agave

net bench





NET BENCH
antracite
CUSCINO NET BENCH
grigio

NET BENCH
senape
CUSCINO NET BENCH
grigio



NET BENCH
senape
CUSCINO NET BENCH
denim





NET BENCH
salice
CUSCINO NET BENCH
the verde
NET TABLE 100
salice



NET BENCH
tortora
CUSCINO NET BENCH
denim
CUSCINO PASSEPARTOUT
tropical - denim
NET RELAX
tortora
CUSCINO NET RELAX
denim
CUSCINO SHELL
denim
NET TABLE 100
tortora

net relax



selected by
ADI DESIGN INDEX 2017



reddot award 2018
winner





NET RELAX
 antracite
CUSCINO NET RELAX
 rosa quarzo
CUSCINO SHELL
 rosa quarzo



NET RELAX
 corallo
CUSCINO NET RELAX
 rosa quarzo

NET RELAX
 senape
CUSCINO NET RELAX
 denim

net





NET
tortora
FIORE
tortora



NET
corallo
CUSCINO NET
rosa quarzo

NET
bianco
CUSCINO NET
bianco

NET
antracite
CUSCINO NET
grey stone



NET
antracite



**NET
SPRITZ**
A Roma - Porec
Croatia

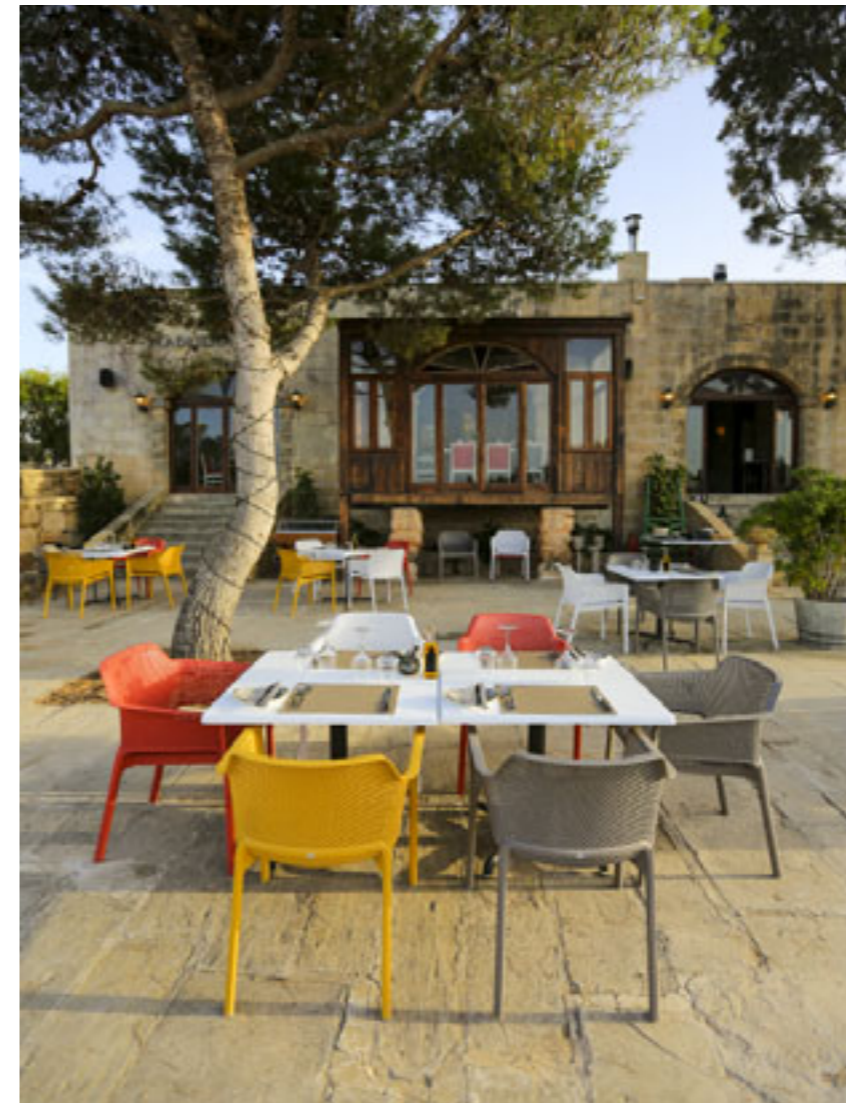

**NET
SCUDO**
Madliena Lodge - Swieqi
Malta

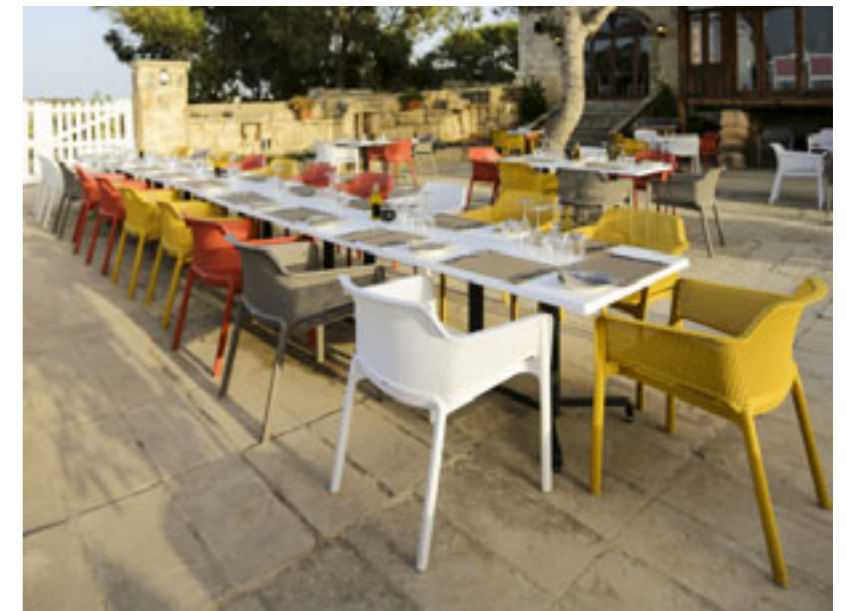



**NET RELAX
SPRITZ**
Skylark Negril Beach Resort - Negril
Jamaica

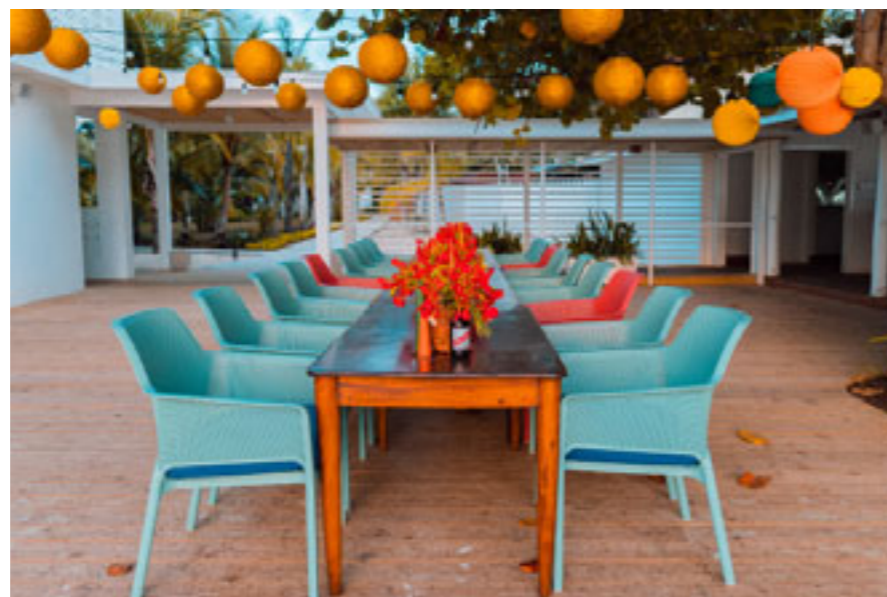

NET RELAX
Moncastro Hotel - Odessa
Ukraine



net table

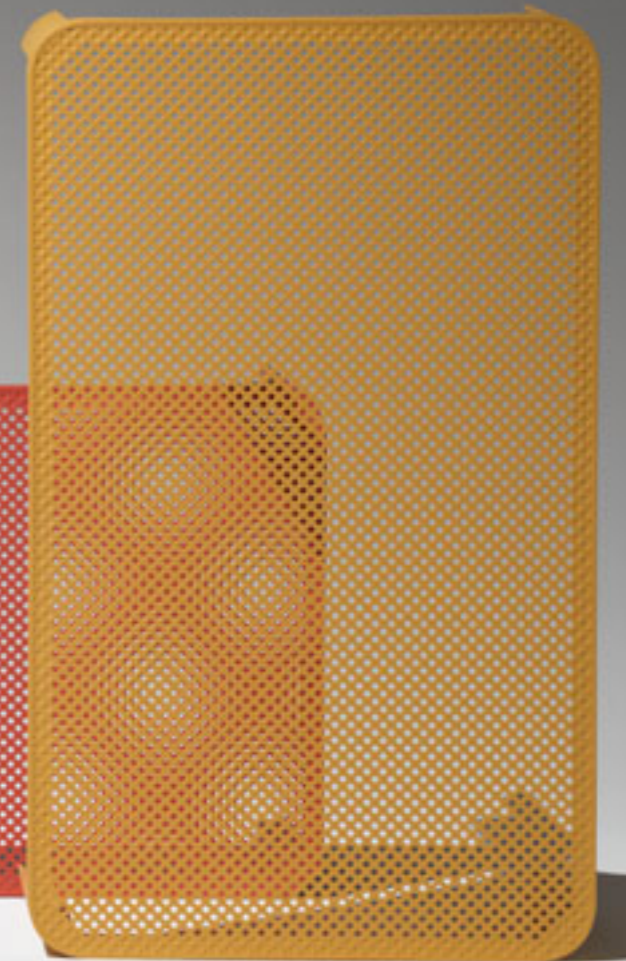
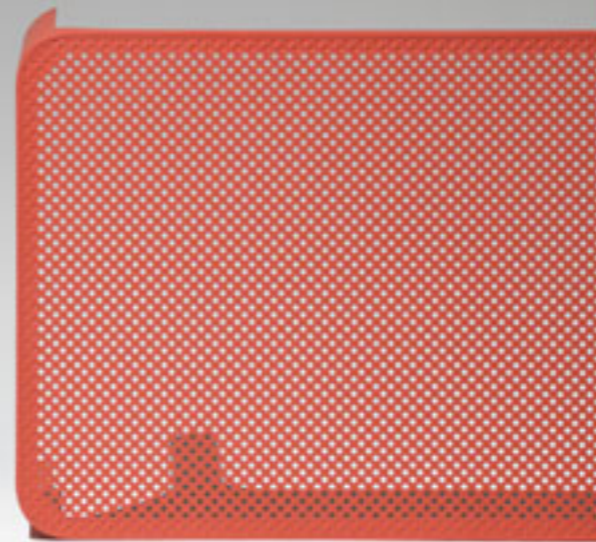
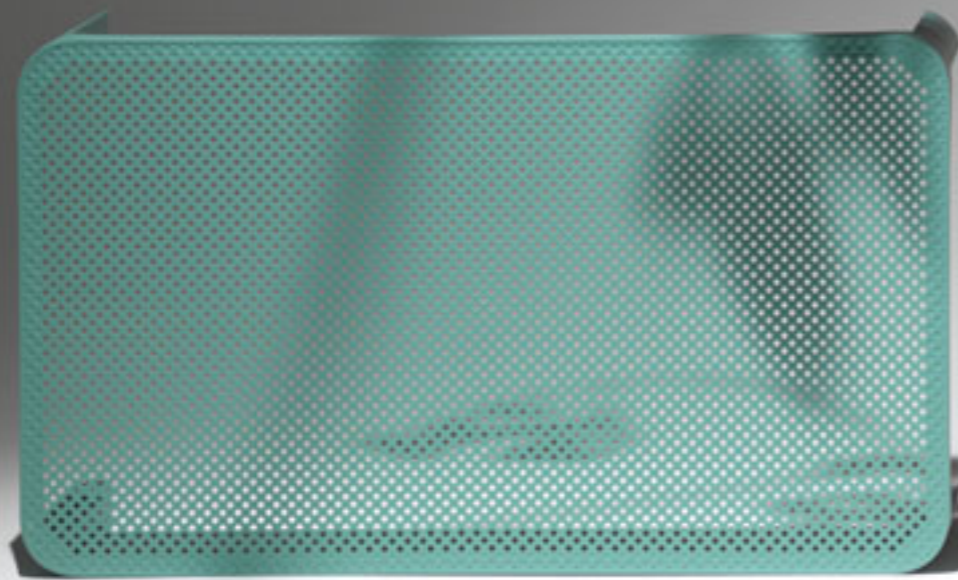



NET TABLE 100
tortora

NET TABLE 100
antracite



NET TABLE 100
bianco
NET BENCH
bianco

bit





BIT
salice



BIT
antracite
BREAK
antracite

**bora
riva
costa**





BORA
rosso



BORA
tortora
CLIP 70
tortora



BORA BISTROT
tortora



RIVA
bianco



RIVA
bianco
FIORÉ
bianco



RIVA BISTROT
celeste
SPRITZ
celeste



COSTA
bianco



COSTA
antracite



COSTA BISTROT
antracite



BORA BISTROT
Skylark Negril Beach
Resort - Negril
Jamaica

RIVA BISTROT
IAAD - Torino
Italy

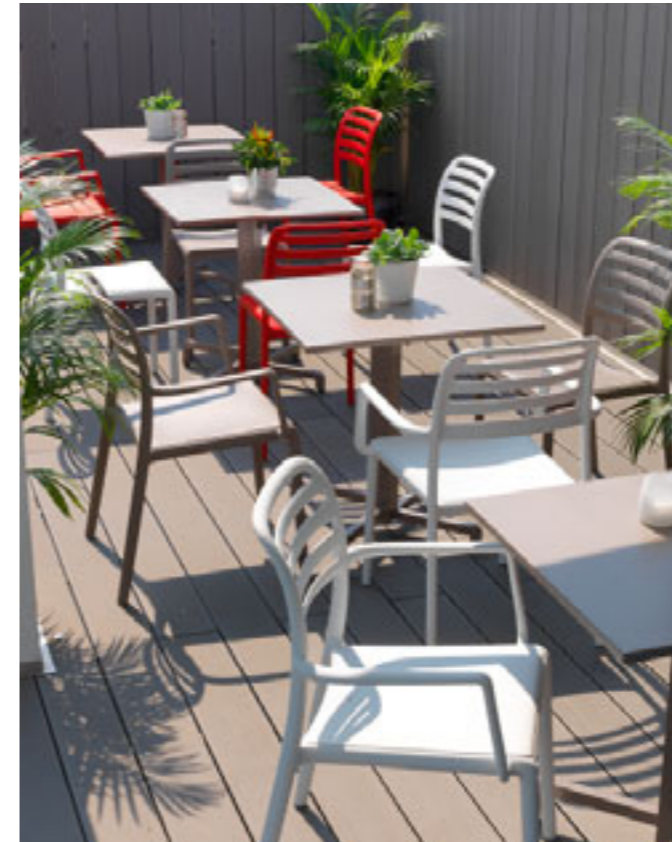

FARO
COSTA BISTROT
Le Chicche - Vicenza
Italy

COSTA
Vicenza
Italy



BORA
BORA BISTROT
Mulino Caffè - Vicenza
Italy

acquamarina darsena





ACQUAMARINA
tortora

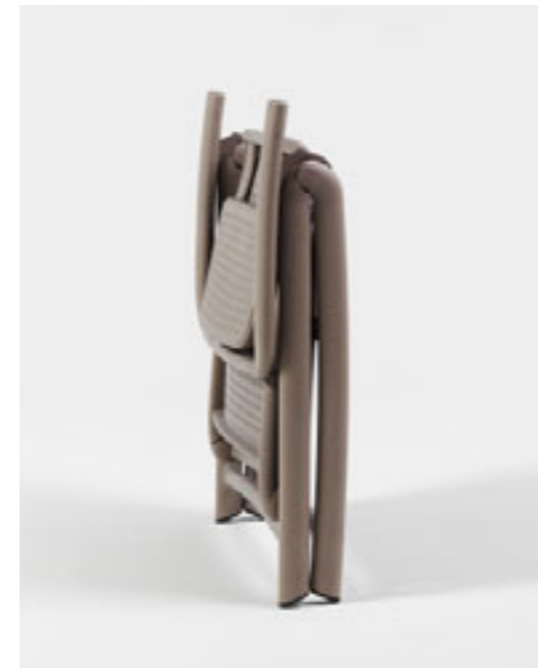

ACQUAMARINA
tortora



ACQUAMARINA
bianco
STEP
bianco

DARSENA
celestre



DARSENA
antracite



DARSENA
antracite



lido faro





LIDO
tortora
LIDO MINI
tortora



LIDO
rosso



FARO
antracite



FARO
tortora
FIORE HIGH
bianco



FARO
antracite

aria
aria tavolino





ARIA POLTRONA
tortora
CUSCINO SEDUTA ARIA
bianco
CUSCINO FIT ARIA
bianco



ARIA POLTRONA
bianco
CUSCINO SEDUTA ARIA
grigio
CUSCINO ARREDO ARIA
grigio

ARIA POLTRONA
tortora
CUSCINO SEDUTA ARIA
grigio
CUSCINO FIT ARIA
grigio
FIORE
tortora



ARIA POLTRONA
 antracite
CUSCINO SEDUTA
 lime
CUSCINO ARREDO
 lime
ARIA TAVOLINO 60
 antracite



ARIA POLTRONA
 tortora
CUSCINO SEDUTA
 caffè
CUSCINO ARREDO
 caffè
ARIA TAVOLINO 100
 tortora





ARIA
 Ammos Beach Bar
 Kos
 Greece



ARIA
 Maris Suites
 Zante
 Greece

ARIA
 Showroom ALU B.V.
 Amsterdam
 Netherlands



ARIA
 Nira Montana - La Thuile
 Italy

palma
erica
gardenia
dalia





PALMA
tortora



PALMA
tortora
CUBE 70
tortora



PALMA
bianco / tortora

ERICA
bianco



ERICA
bianco
CUBE 70
bianco



DALIA
tortora

GARDENIA
bianco / tortora



ninfea loto





NINFEA RELAX
 antracite
LOTO RELAX 95
 antracite



NINFEA RELAX
 bianco



LOTO RELAX 95
 bianco
LOTO RELAX 60
 bianco



NINFEA DINNER
antracite
FLUTE
antracite



NINFEA DINNER
antracite



NINFEA DINNER
bianco

dama
regina
duca





DAMA
tortora
DAMA
burro



DAMA
tortora



DAMA
tortora



REGINA
antracite



REGINA
burro
REGINA
antracite



REGINA
antracite
CALICE
antracite



DUCA
tortora
SCUDO HIGH
tortora



cube





CUBE 70
tortora

CUBE 80
tortora
CUBE 70
tortora
CUBE 70 HIGH
tortora

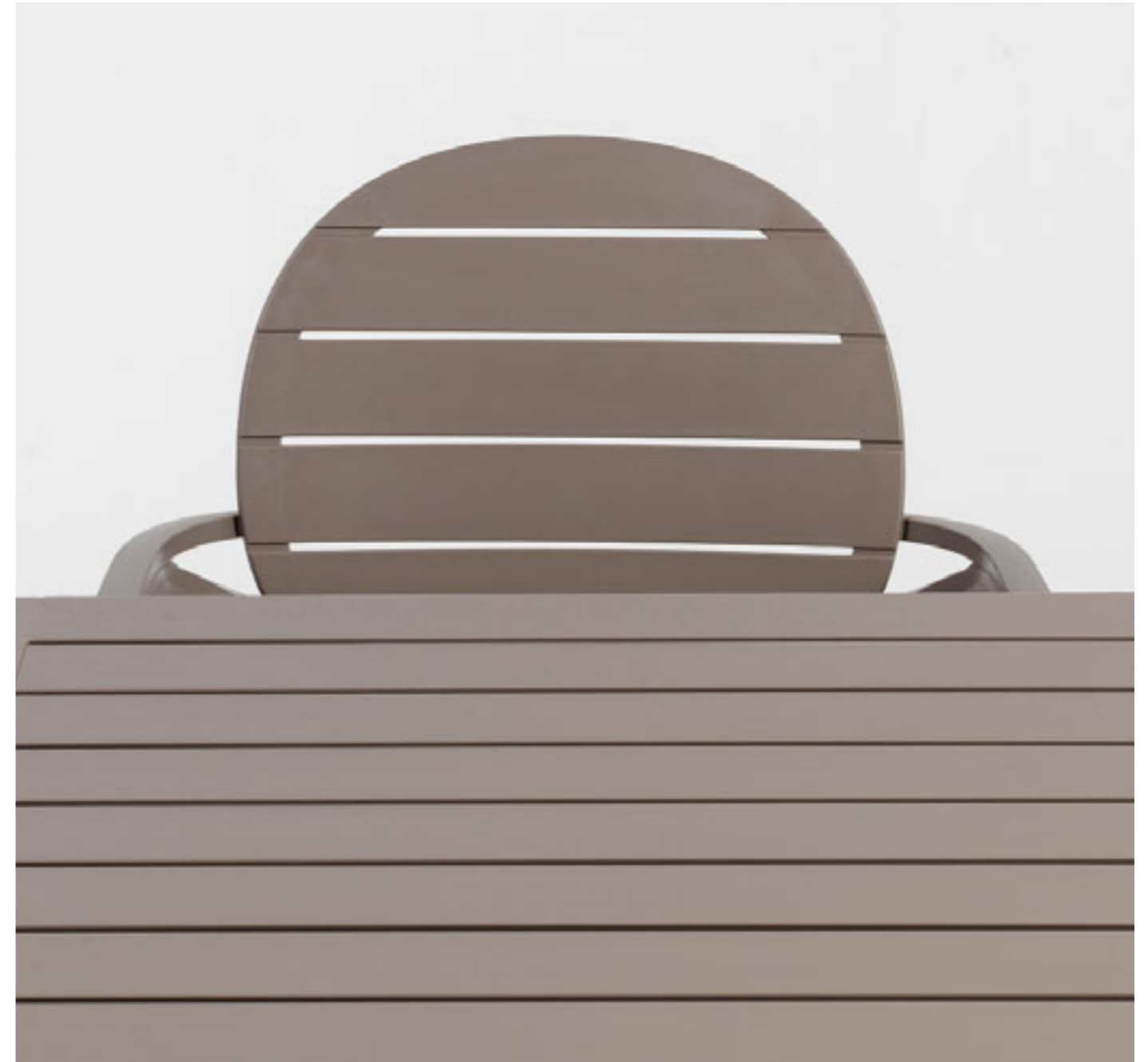

CUBE 80
tortora
PALMA
tortora

clip





CLIP 80
tortora
BORA
tortora

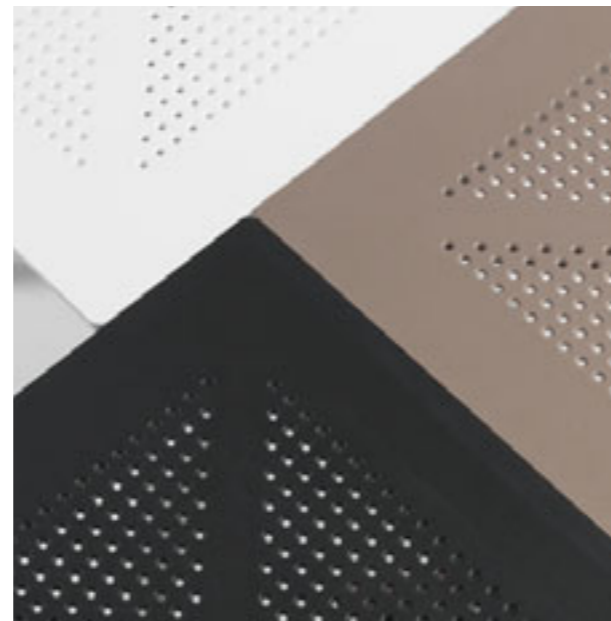

CLIP 80
tortora
CLIP 70
tortora
BORA
tortora



CLIPX 80
tortora
NET
tortora

step spritz





STEP
rosso



STEP
tortora
BORA BISTROT
tortora



SPRITZ
antracite
SPRITZ MINI
tortora

fiore
ibisco



FIORE HIGH
bianco - piano DurelTOP 70x70 bianco
FIORE
bianco - piano DurelTOP 70x70 bianco
FARO
celeste
RIVA BISTROT
celeste



FIORE
bianco - piano DurelTOP 70x70 bianco



IBISCO
tortora
piano Laminato 80x80 tortora



IBISCO
tortora
piano Laminato 80x80 tortora



IBISCO HIGH
antracite
piano Laminato 70x70 antracite

flute break





FLUTE
bianco
piano Laminato ø70 bianco

FLUTE
antracite
piano Laminato ø70 antracite



BREAK
bianco
piano Laminato ø70 bianco

BREAK
antracite
piano Laminato ø70 antracite



FLUTE
tortora
piano Laminato ø70 tortora



scudo



SCUDO
tortora
piano Laminato 80x80 tortora



SCUDO HIGH
tortora
piano Laminato 70x70 tortora
SCUDO
tortora
piano Laminato 70x70 tortora



SCUDO DOUBLE
antracite

atlantico pop

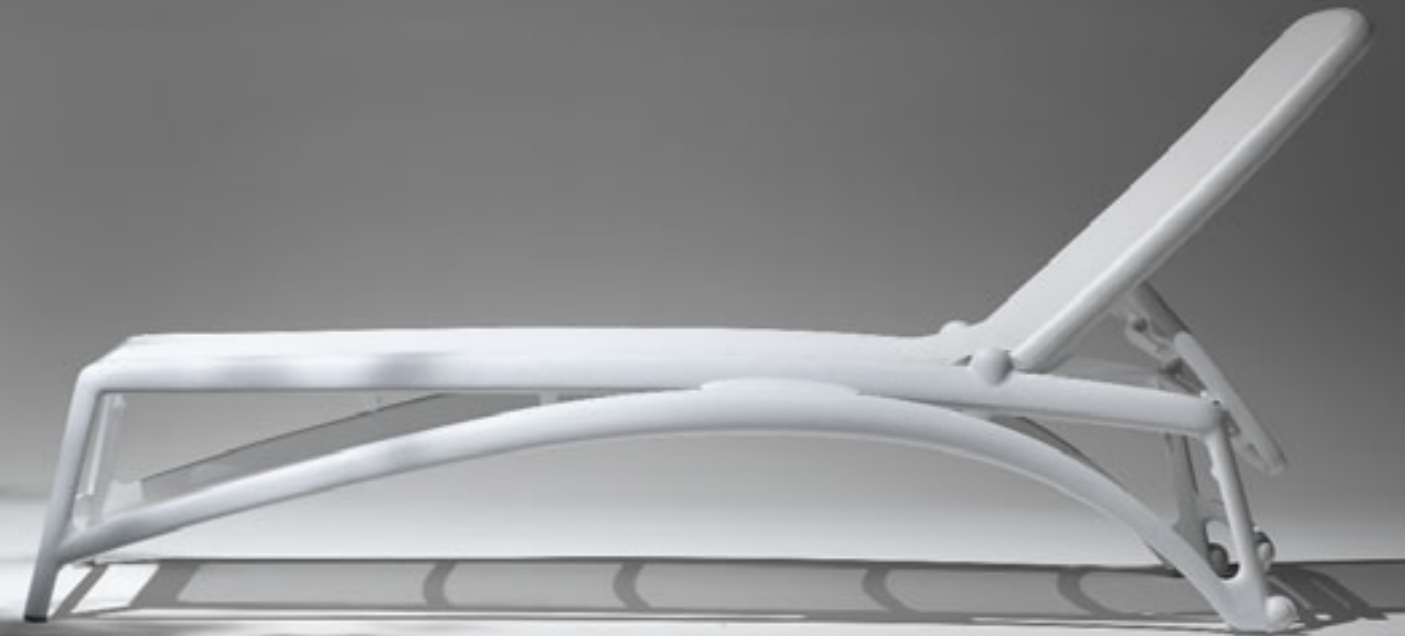



ATLANTICO
 antracite
POP
 antracite



ATLANTICO
 tortora

ATLANTICO
 bianco / tortora





ATLANTICO
 bianco / celeste
 bianco / rosa
 bianco / prato



ATLANTICO
 tortora / tortora



POP
 tortora

**ATLANTICO
SPRITZ**
Villa Aieni - Puglia
Italy



ATLANTICO
Sunmelia BeachResort Hotel & Spa - Antalya
Turkey



ATLANTICO
Aqua Breeze Villas - Naxos
Greece



ATLANTICO
Deltapark Resort - Thun
Swiss



ATLANTICO
Moncastro Hotel - Odessa
Ukraine



alfa
omega





OMEGA
tortora / tortora

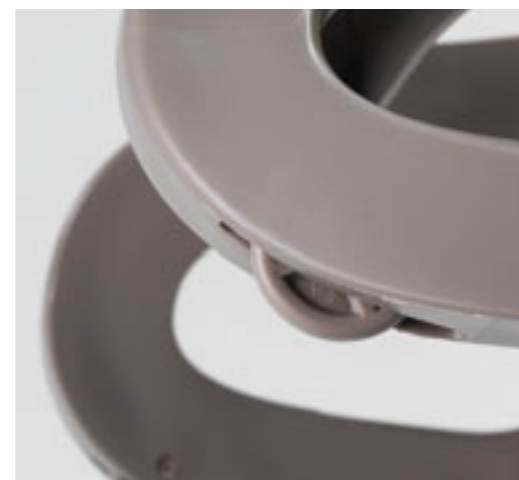

ALFA
tortora / tortora

OMEGA
Greece



OMEGA
Agrumare Farm Holiday - Matera
Italy

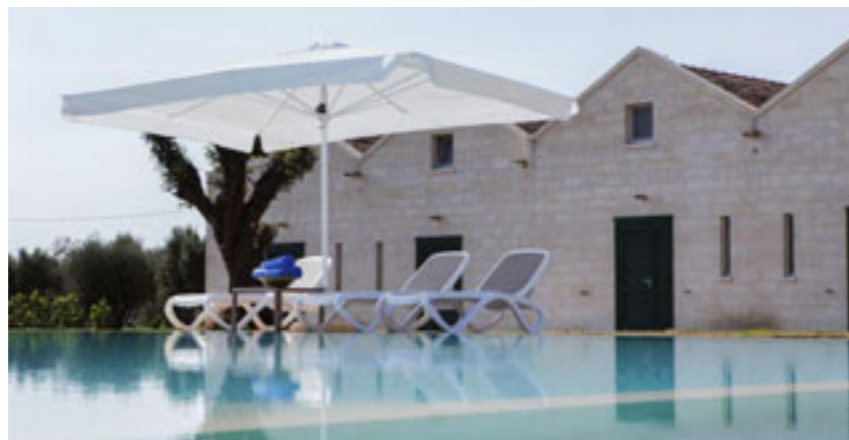

ALFA
Cave Bianche Hotel - Trapani
Italy

schede tecniche
technical details



KOMODO 5 **new**

polipropilene fiberglass
tessuto

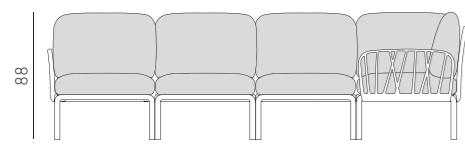
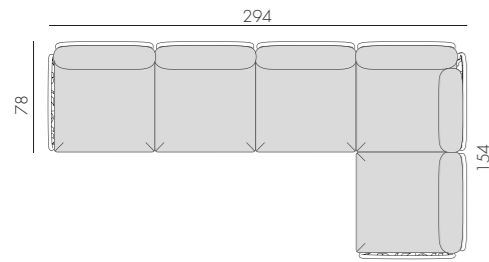

41,1 kg
n. pz. 1

BIANCO grigio 40370.00.163	BIANCO rosa quarzo 40370.00.066	BIANCO canvas Sunbrella® 40370.00.141	BIANCO adriatic Sunbrella® 40370.00.142
ANTRACITE grigio 40370.02.163	ANTRACITE rosa quarzo 40370.02.066	ANTRACITE canvas Sunbrella® 40370.02.141	ANTRACITE adriatic Sunbrella® 40370.02.142
TORTORA grigio 40370.10.163	TORTORA rosa quarzo 40370.10.066	TORTORA canvas Sunbrella® 40370.10.141	TORTORA adriatic Sunbrella® 40370.10.142

SOLUTIONS

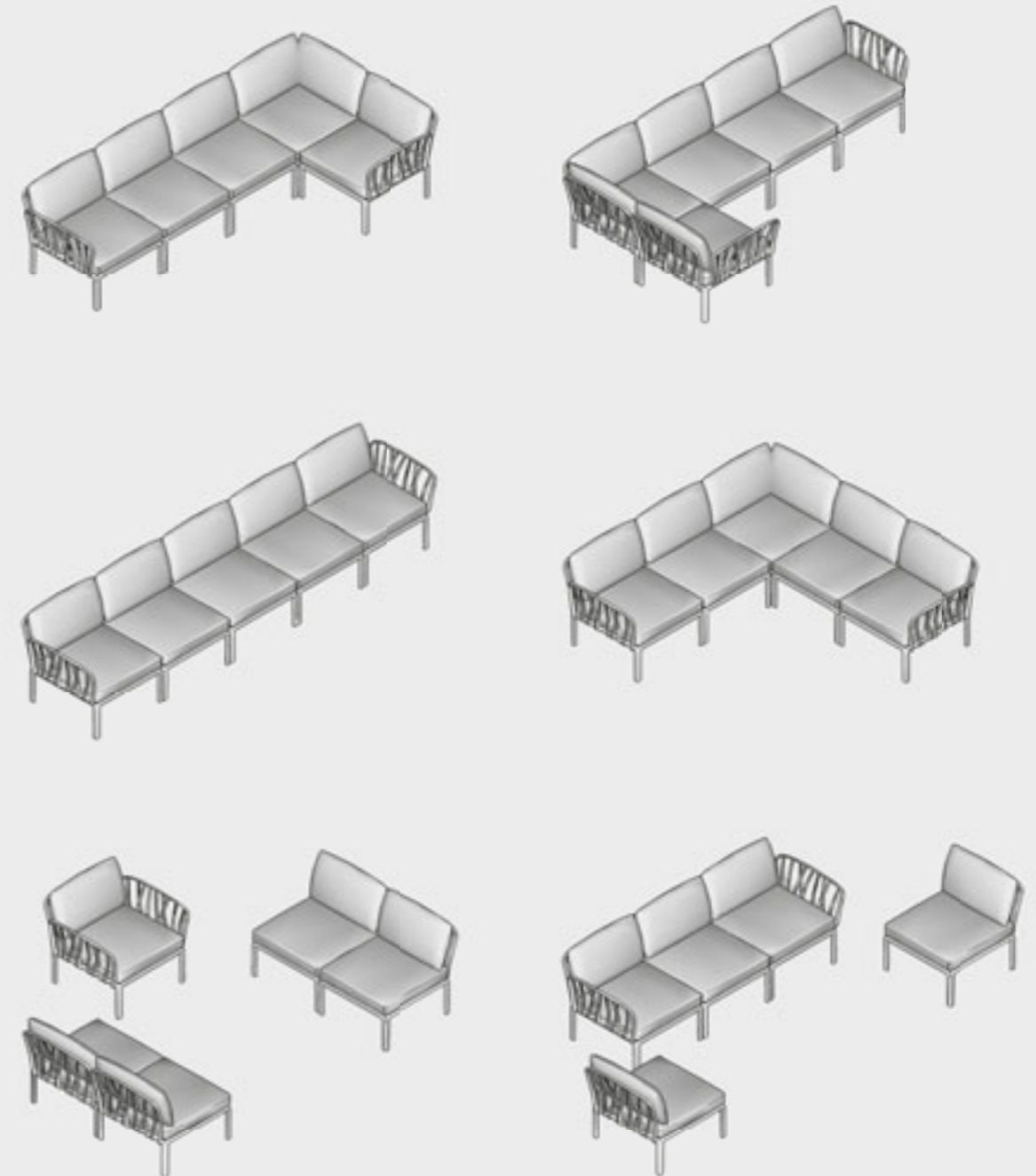

KOMODO è un divano modulare configurabile a piacere. Le sedute possono essere fissate tra loro e gli schienali e i braccioli sono agganciabili su tutti i lati.

Oltre alla versione standard KOMODO 5, è possibile configurare e ordinare la tua versione di KOMODO elencando tutti i singoli componenti che lo formano.

KOMODO is a modular sofa which can be configured to suit your particular needs. The seats can be secured to one another and the seat backs and armrests can be attached on all sides.

In addition to the standard KOMODO 5 version, you can configure and order your own version of KOMODO simply by listing all the individual components you require.

KOMODO BRACCIOLO **new**

polipropilene fiberglass

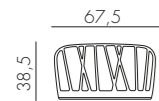

1,7 kg
n. pz. 2

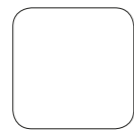

BIANCO
40375.00.000



ANTRACITE
40375.02.000



TORTORA
40375.10.000

KOMODO SCHIENALE **new**

polipropilene fiberglass

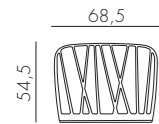

2 kg
n. pz. 4

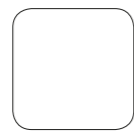

BIANCO
40376.00.000



ANTRACITE
40376.02.000



TORTORA
40376.10.000

KOMODO SEDUTA **new**

polipropilene fiberglass

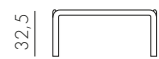
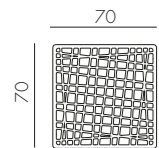

5,1 kg
n. pz. 4



BIANCO
40377.00.000



ANTRACITE
40377.02.000



TORTORA
40377.10.000

KOMODO TAVOLINO **new**

polipropilene fiberglass

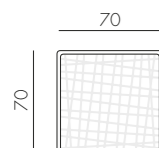

6,7 kg
n. pz. 1



BIANCO
40378.00.000



ANTRACITE
40378.02.000



TORTORA
40378.10.000

CUSCINO SCHIENALE KOMODO **new**

tessuto

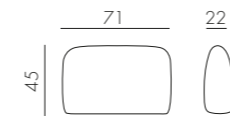

1,3 kg
n. pz. 1



grigio
36370.52.163



rosa quarzo
36370.52.066



canvas Sunbrella®
36370.52.141



adriatic Sunbrella®
36370.52.142

CUSCINO SCHIENALE ANGOLO KOMODO **new**

tessuto

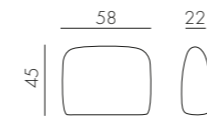

1,1 kg
n. pz. 1



grigio
36370.54.163



rosa quarzo
36370.54.066



canvas Sunbrella®
36370.54.141

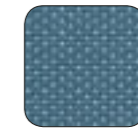

adriatic Sunbrella®
36370.54.142

CUSCINO SEDUTA KOMODO **new**

tessuto

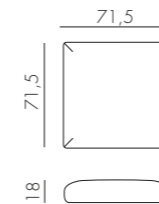

2,4 kg
n. pz. 1



grigio
36370.60.163



rosa quarzo
36370.60.066



canvas Sunbrella®
36370.60.141

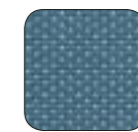

adriatic Sunbrella®
36370.60.142

KOMODO WALL **new**

polipropilene fiberglass

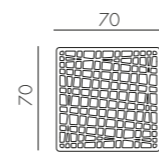

11,5 kg
n. pz. 1

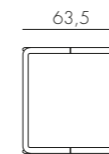

BIANCO
40379.00.000



ANTRACITE
40379.02.000



TORTORA
40379.10.000

TRILL ARMCHAIR **new**

polipropilene fiberglass

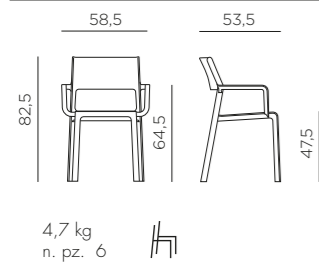

BIANCO 40250.00.000 ANTRACITE 40250.02.000 TORTORA 40250.10.000 AGAVE 40250.16.000 OTTANIO 40250.49.000 TABACCO 40250.53.000 SENAPE 40250.56.000

4,7 kg
n. pz. 6



TRILL BISTROT **new**

polipropilene fiberglass

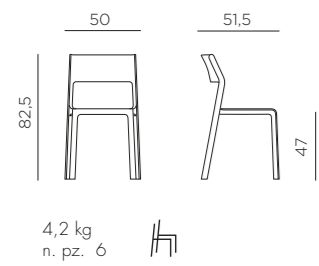

BIANCO 40253.00.000 ANTRACITE 40253.02.000 TORTORA 40253.10.000 AGAVE 40253.16.000 OTTANIO 40253.49.000 TABACCO 40253.53.000 SENAPE 40253.56.000

4,2 kg
n. pz. 6



TRILL STOOL **new**

polipropilene fiberglass

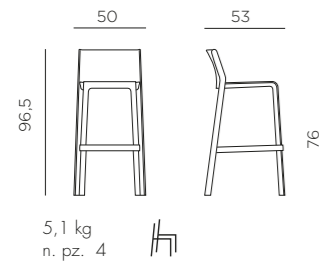

BIANCO 40350.00.000 ANTRACITE 40350.02.000 TORTORA 40350.10.000 AGAVE 40350.16.000 OTTANIO 40350.49.000 TABACCO 40350.53.000 SENAPE 40350.56.000

5,1 kg
n. pz. 4



TRILL STOOL MINI **new**

polipropilene fiberglass

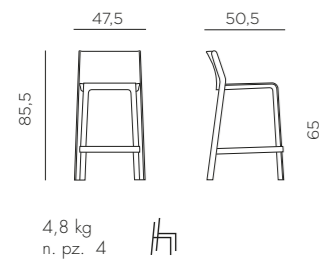

BIANCO 40353.00.000 ANTRACITE 40353.02.000 TORTORA 40353.10.000 AGAVE 40353.16.000 OTTANIO 40353.49.000 TABACCO 40353.53.000 SENAPE 40353.56.000

4,8 kg
n. pz. 4



NET BENCH

polipropilene fiberglass

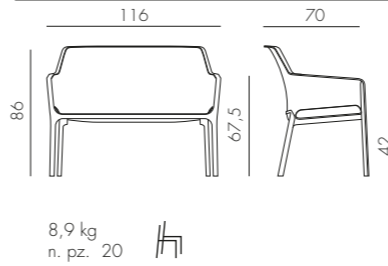

BIANCO 40338.00.000 ANTRACITE 40338.02.000 SALICE 40338.04.000 TORTORA 40338.10.000 SENAPE 40338.56.000 CORALLO 40338.75.000

8,9 kg
n. pz. 20



NET RELAX

polipropilene fiberglass

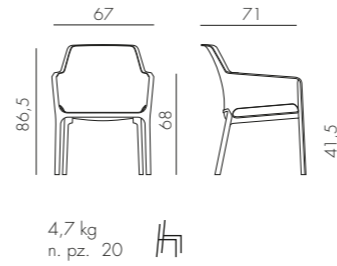

BIANCO 40327.00.000 ANTRACITE 40327.02.000 SALICE 40327.04.000 TORTORA 40327.10.000 SENAPE 40327.56.000 CORALLO 40327.75.000

4,7 kg
n. pz. 20



NET

polipropilene fiberglass

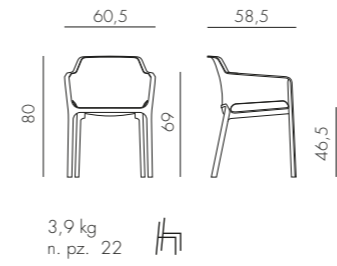

BIANCO 40326.00.000 ANTRACITE 40326.02.000 SALICE 40326.04.000 TORTORA 40326.10.000 SENAPE 40326.56.000 CORALLO 40326.75.000

3,9 kg
n. pz. 22



BIT

polipropilene fiberglass

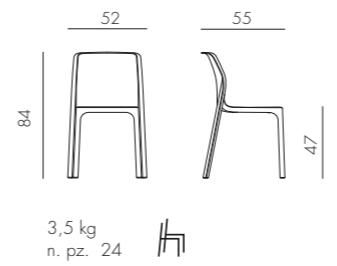

BIANCO 40328.00.000 ANTRACITE 40328.02.000 SALICE 40328.04.000 TORTORA 40328.10.000 SENAPE 40328.56.000 CORALLO 40328.75.000

3,5 kg
n. pz. 24



BORA

polipropilene fiberglass

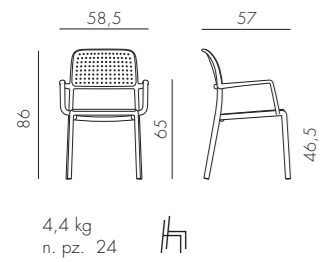

COSTA

polipropilene fiberglass

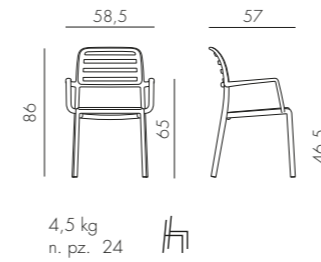

BORA BISTROT

polipropilene fiberglass

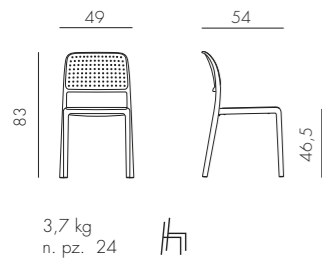

COSTA BISTROT

polipropilene fiberglass

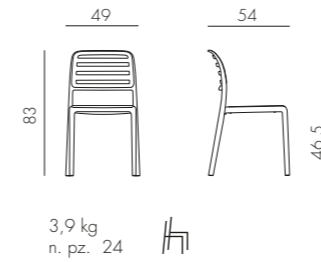

RIVA

polipropilene fiberglass

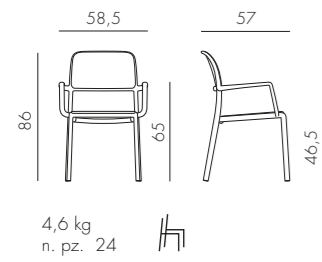

LIDO

polipropilene fiberglass

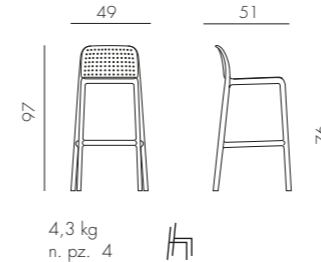

RIVA BISTROT

polipropilene fiberglass

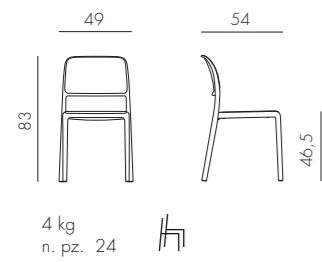

LIDO MINI

polipropilene fiberglass

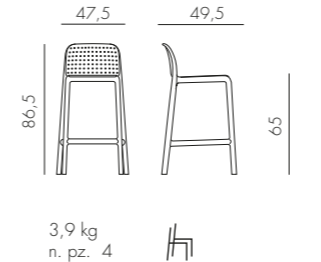

FARO

polipropilene fiberglass

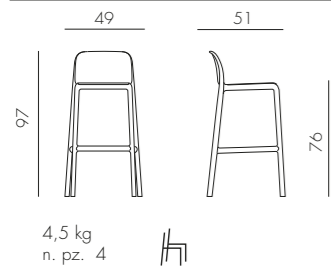

FARO MINI

polipropilene fiberglass

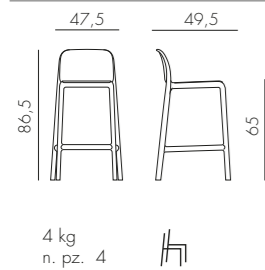

ACQUAMARINA

polipropilene fiberglass

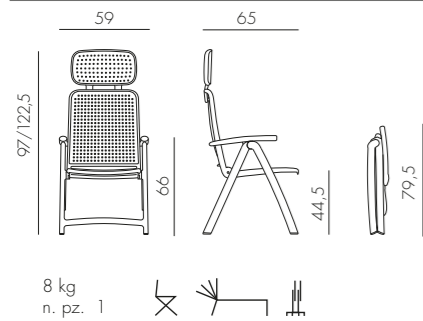

DARSENA

polipropilene fiberglass

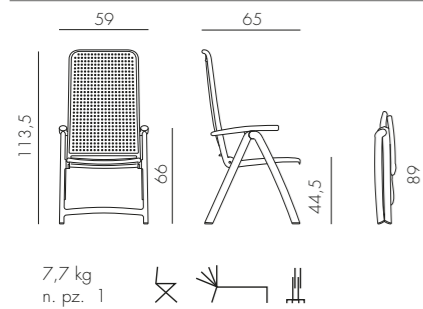

PALMA

polipropilene

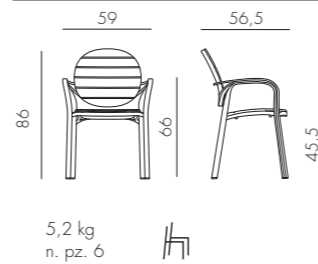

ERICA

polipropilene

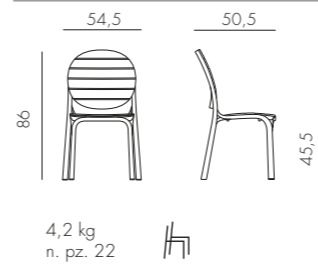

GARDENIA

polipropilene

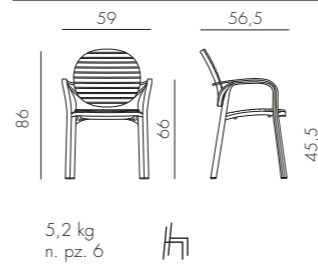

DALIA

polipropilene

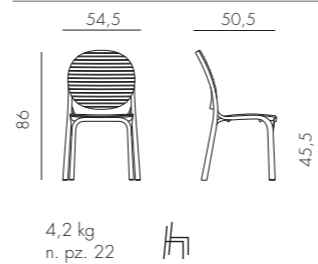

ARIA (POLTRONA ARIA + CUSCINO SEDUTA + CUSCINO ARREDO)

polipropilene
tessuto

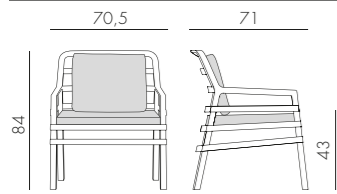

7,9 kg
n. pz. 1

BIANCO lime 40330.00.061.061	ANTRACITE lime 40330.02.061.061	CAFFÈ lime 40330.05.061.061	TORTORA lime 40330.10.061.061
BIANCO cherry 40330.00.065.065	ANTRACITE cherry 40330.02.065.065	CAFFÈ cherry 40330.05.065.065	TORTORA cherry 40330.10.065.065
BIANCO melanzana 40330.00.068.068	ANTRACITE melanzana 40330.02.068.068	CAFFÈ melanzana 40330.05.068.068	TORTORA melanzana 40330.10.068.068
BIANCO bianco 40330.00.155.155	ANTRACITE bianco 40330.02.155.155	CAFFÈ bianco 40330.05.155.155	TORTORA bianco 40330.10.155.155
BIANCO caffè 40330.00.165.165	ANTRACITE caffè 40330.02.165.165	CAFFÈ caffè 40330.05.165.165	TORTORA caffè 40330.10.165.165
BIANCO grigio 40330.00.163.163	ANTRACITE grigio 40330.02.163.163	CAFFÈ grigio 40330.05.163.163	TORTORA grigio 40330.10.163.163
BIANCO grigio Sunbrella® 40330.00.136.136	ANTRACITE grigio Sunbrella® 40330.02.136.136	CAFFÈ grigio Sunbrella® 40330.05.136.136	TORTORA grigio Sunbrella® 40330.10.136.136

* Disponibile a magazzino
Available ex-stock
Disponible sur stock
Ab Lager verfügbar
Disponible en almacén habitualmente
Disponível em estoque
Stokta mevcut
Наличие на складе

* Disponibile su ordine
Available to order
Disponible sur commande
Mit Auftrag verfügbar
Disponible sólo sobre pedido
Disponível sob encomenda
Sipariş göre hazırlanacaktır
Под заказ

ARIA FIT (POLTRONA ARIA + CUSCINO SEDUTA + CUSCINO FIT)

polipropilene
tessuto

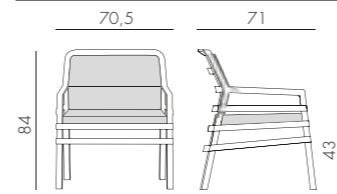

7,9 kg
n. pz. 1

BIANCO bianco 40330.00.155.FIT	ANTRACITE bianco 40330.02.155.FIT	CAFFÈ bianco 40330.05.155.FIT	TORTORA bianco 40330.10.155.FIT
BIANCO caffè 40330.00.165.FIT	ANTRACITE caffè 40330.02.165.FIT	CAFFÈ caffè 40330.05.165.FIT	TORTORA caffè 40330.10.165.FIT
BIANCO grigio 40330.00.163.FIT	ANTRACITE grigio 40330.02.163.FIT	CAFFÈ grigio 40330.05.163.FIT	TORTORA grigio 40330.10.163.FIT
BIANCO grigio Sunbrella® 40330.00.136.FIT	ANTRACITE grigio Sunbrella® 40330.02.136.FIT	CAFFÈ grigio Sunbrella® 40330.05.136.FIT	TORTORA grigio Sunbrella® 40330.10.136.FIT

* Disponibile su ordine
Available to order
Disponible sur commande
Mit Auftrag verfügbar
Disponible sólo sobre pedido
Disponível sob encomenda
Sipariş göre hazırlanacaktır
Под заказ

NINFEA DINNER

polipropilene
alluminio

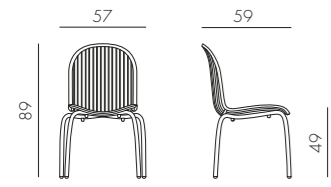

4,5 kg
n. pz. 6



ANTRACITE
verniciato antracite
62052.02.000

BIANCO
verniciato bianco
62053.00.000

NINFEA RELAX

polipropilene
alluminio

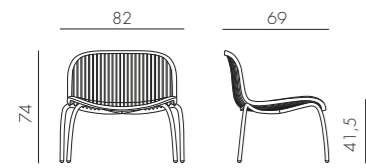

7,2 kg
n. pz. 2



ANTRACITE
verniciato antracite
62252.02.000

BIANCO
verniciato bianco
62253.00.000

DAMA

polipropilene fibreglass
alluminio

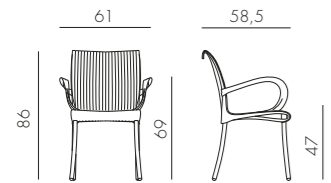

4,1 kg
n. pz. 18



ANTRACITE
verniciato antracite
61652.02.000

CAFFÈ
verniciato caffè
61657.05.000

BURRO
verniciato burro
61658.28.000

TORTORA
verniciato tortora
61659.10.000

REGINA

polipropilene fibreglass
alluminio

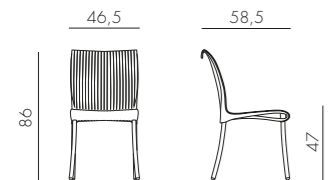

3,3 kg
n. pz. 18



ANTRACITE
verniciato antracite
61852.02.000

CAFFÈ
verniciato caffè
61857.05.000

BURRO
verniciato burro
61858.28.000

TORTORA
verniciato tortora
61859.10.000

DUCA

polipropilene fibreglass
alluminio

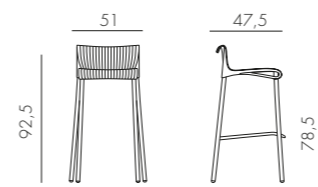

3,9 kg
n. pz. 4



ANTRACITE
verniciato antracite
75252.02.000

CAFFÈ
verniciato caffè
75257.05.000

BURRO
verniciato burro
75258.28.000

TORTORA
verniciato tortora
75259.10.000

MUSA

polipropilene
alluminio

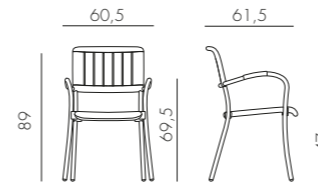

4,2 kg
n. pz. 24



BIANCO
verniciato bianco
61053.00.000

ANTRACITE
verniciato antracite
61052.02.000

CAFFÈ
verniciato caffè
61057.05.000

TORTORA
verniciato tortora
61059.10.000

ARTICA WICKER

polipropilene
alluminio

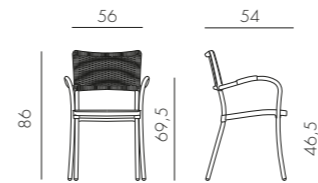

3,3 kg
n. pz. 24



ANTRACITE
anodizzato argento
60150.02.000

CAFFÈ
anodizzato argento
60150.05.000

ANTRACITE
verniciato antracite
60152.02.000

AURORA

polipropilene
alluminio

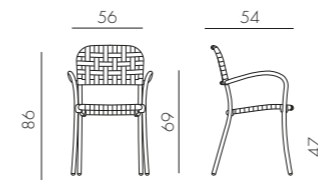

3,3 kg
n. pz. 24



BIANCO
anodizzato argento
60250.00.000

ANTRACITE
anodizzato argento
60250.02.000

CAFFÈ
anodizzato argento
60250.05.000

ANTRACITE
verniciato antracite
60252.02.000

ATLANTICO

polipropilene fiberglass
tessuto sintetico 1 x 1

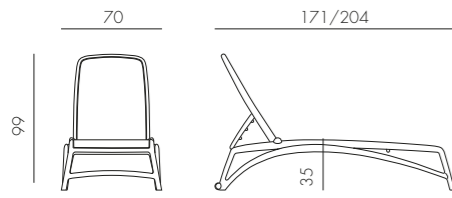

16 kg
n. pz. 20

Tessuto ricambiabile
Replaceable fabric
Tissu changeable
Auswechselbarer Stoff
Tela sustituible
Tecidos recambiáveis
Değiştirilebilen Kumaş
Съемная ткань

BIANCO rosa 40450.00.056	BIANCO celeste 40450.00.075	BIANCO mandarino 40450.00.083	BIANCO prato 40450.00.084	BIANCO blu 40450.00.102
BIANCO tortora 40450.00.104	BIANCO bianco 40450.00.107	ANTRACITE antracite 40450.02.057	ANTRACITE celeste 40450.02.075	CAFFÈ tortora 40450.05.104
CAFFÈ prato 40450.05.084	CAFFÈ celeste 40450.05.075	TORTORA celeste 40450.10.075	TORTORA tortora 40450.10.104	TORTORA bianco 40450.10.107

BRACCIOLO ATLANTICO

polipropilene fiberglass

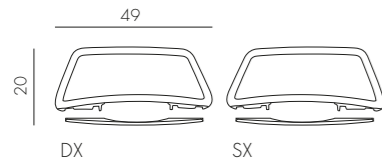

1,1 kg
n. pz. 1

BIANCO 40452.00.000	ANTRACITE 40452.02.000	CAFFÈ 40452.05.000	TORTORA 40452.10.000

RICAMBIO atlantico

resina acetilica
tessuto sintetico 1 x 1

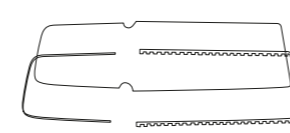

1,3 kg
n. pz. 1

rosa 40460.00.056	celeste 40460.00.075	mandarino 40460.00.083	prato 40460.00.084	blu 40460.00.102
tortora 40460.00.104	bianco 40460.00.107	antracite 40460.01.057	celeste 40460.01.075	prato 40460.01.084
tortora 40460.01.104				

ALFA

polipropilene
tessuto sintetico

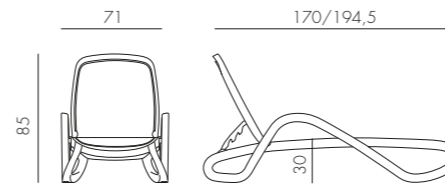

14 kg
n. pz. 17

Tessuto ricambiabile
Replaceable fabric
Tissu changeable
Auswechselbarer Stoff
Tela sustituible
Tecidos recambiáveis
Değiştirilebilen Kumaş
Съемная ткань

BIANCO trama beige 40416.00.078	BIANCO bianco 40416.00.108	BIANCO blu 40416.00.112	BIANCO beige 40416.00.115	BIANCO trama bianco 40416.00.121
BIANCO tortora 40416.00.124	ANTRACITE trama beige 40416.02.078	ANTRACITE trama antracite 40416.02.116	CAFFÈ trama beige 40416.05.078	CAFFÈ beige 40416.05.115
CAFFÈ trama caffè 40416.05.117	TORTORA trama bianco 40416.10.121	TORTORA tortora 40416.10.124		

OMEGA

polipropilene
tessuto sintetico

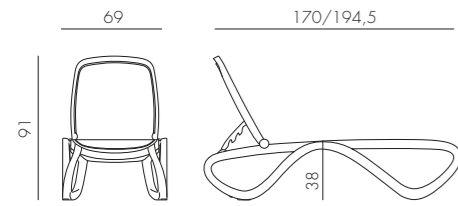

14,3 kg
n. pz. 18

Tessuto ricambiabile
Replaceable fabric
Tissu changeable
Auswechselbarer Stoff
Tela sustituible
Tecidos recambiáveis
Değiştirilebilen Kumaş
Съемная ткань



EDEN

polipropilene

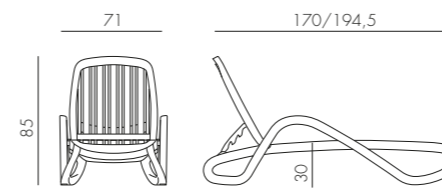

14,7 kg
n. pz. 17



TROPICO

polipropilene

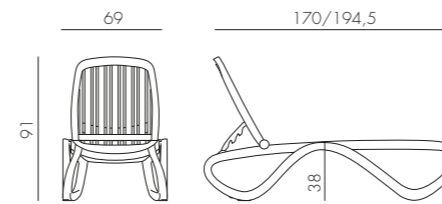

15,1 kg
n. pz. 18

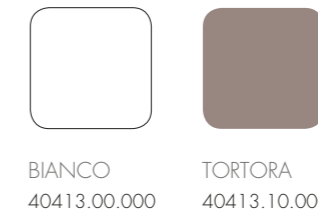

PARASOLE

ALFA - OMEGA - EDEN - TROPICO

polipropilene
tessuto sintetico

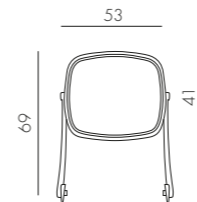

1,4 kg
n. pz. 1



RICAMBIO ALFA OMEGA

resina acetalica
tessuto sintetico

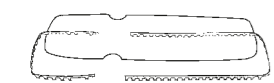

1,6 kg
n. pz. 1



CLIP 80

durelTOP
polipropilene fiberglass

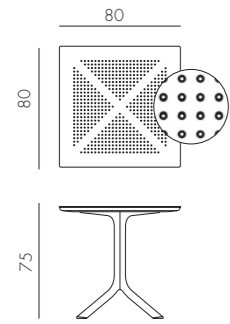

BIANCO 40082.00.000
ANTRACITE 40082.02.000
TORTORA 40082.10.000

12,1 kg
n. pz. 1

CLIP 70

durelTOP
polipropilene fiberglass

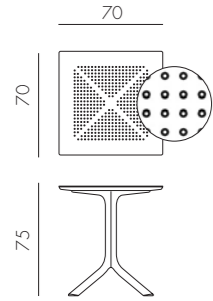

BIANCO 40084.00.000
ANTRACITE 40084.02.000
TORTORA 40084.10.000

11 kg
n. pz. 1

CLIPX 80 **new**

durelTOP
polipropilene fiberglass

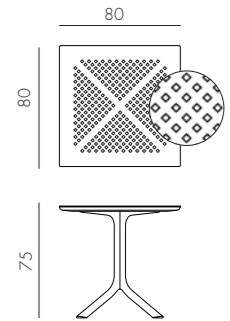

BIANCO 40083.00.000
ANTRACITE 40083.02.000
TORTORA 40083.10.000

12,1 kg
n. pz. 1

CLIPX 70 **new**

durelTOP
polipropilene fiberglass

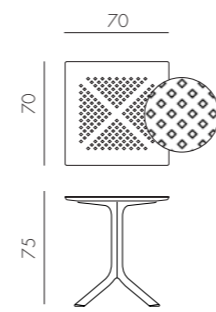

BIANCO 40085.00.000
ANTRACITE 40085.02.000
TORTORA 40085.10.000

11 kg
n. pz. 1

BASE CLIP **new**

TOP Ø80 - 70X70 - 80X80

polipropilene fiberglass

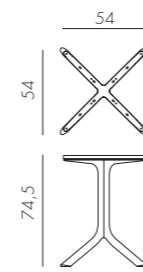

BIANCO 40088.00.000
ANTRACITE 40088.02.000
TORTORA 40088.10.000

7,7 kg
n. pz. 1

STEP

polipropilene fiberglass

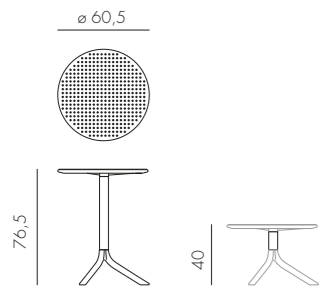

4,2 kg
n. pz. 1



BIANCO 40056.00.000 ANTRACITE 40056.02.000 CAFFÈ 40056.05.000 ROSSO 40056.07.000 TORTORA 40056.10.000 CELESTE 40056.39.000

SPRITZ

polipropilene fiberglass

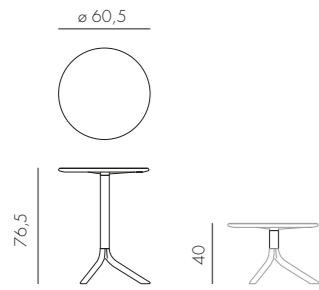

4,3 kg
n. pz. 1



BIANCO 40058.00.000 ANTRACITE 40058.02.000 CAFFÈ 40058.05.000 ROSSO 40058.07.000 TORTORA 40058.10.000 CELESTE 40058.39.000

NET TABLE 100

polipropilene fiberglass

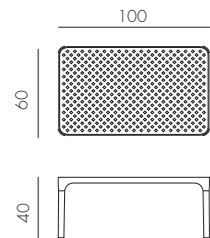

6,3 kg
n. pz. 1



BIANCO 40064.00.000 ANTRACITE 40064.02.000 SALICE 40064.04.000 TORTORA 40064.10.000 SENAPE 40064.56.000 CORALLO 40064.75.000

ARIA TAVOLINO 100

polipropilene

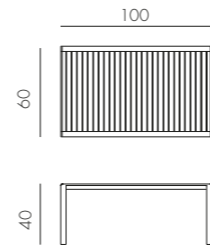

8 kg
n. pz. 1



BIANCO 40052.00.000 ANTRACITE 40052.02.000 CAFFÈ 40052.05.000 TORTORA 40052.10.000

ARIA TAVOLINO 60

polipropilene

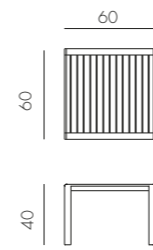

5 kg
n. pz. 1



BIANCO 40051.00.000 ANTRACITE 40051.02.000 CAFFÈ 40051.05.000 TORTORA 40051.10.000

POP new

polipropilene fiberglass

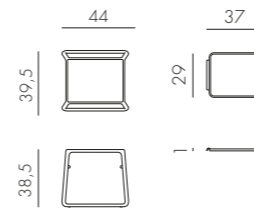

2,5 kg
n. pz. 4



BIANCO 40048.00.000 ANTRACITE 40048.02.000 CAFFÈ 40048.05.000 TORTORA 40048.10.000

CUBE 80

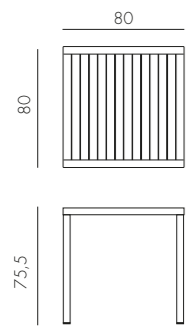

11,5 kg
n. pz. 1



BIANCO verniciato bianco 48053.00.000	ANTRACITE verniciato antracite 48052.02.000	CAFFÈ verniciato caffè 48057.05.000	TORTORA verniciato tortora 48059.10.000
---	---	---	---

durelTOP - polipropilene
alluminio

CUBE 70

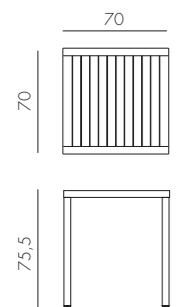

9,5 kg
n. pz. 1



BIANCO verniciato bianco 47853.00.000	ANTRACITE verniciato antracite 47852.02.000	CAFFÈ verniciato caffè 47857.05.000	TORTORA verniciato tortora 47859.10.000
---	---	---	---

durelTOP - polipropilene
alluminio

KIT CUBE 80 HIGH **new**

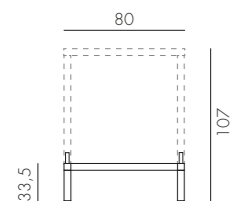

4,4 kg
n. pz. 1



verniciato bianco 48153.00.000	verniciato antracite 48152.02.000	verniciato caffè 48157.05.000	verniciato tortora 48159.10.000
-----------------------------------	--------------------------------------	----------------------------------	------------------------------------

polipropilene
alluminio

KIT CUBE 70 HIGH

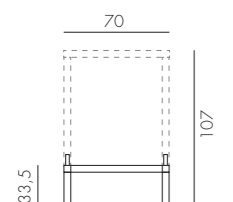

4 kg
n. pz. 1



verniciato bianco 47953.00.000	verniciato antracite 47952.02.000	verniciato caffè 47957.05.000	verniciato tortora 47959.10.000
-----------------------------------	--------------------------------------	----------------------------------	------------------------------------

polipropilene
alluminio

MAESTRALE 90

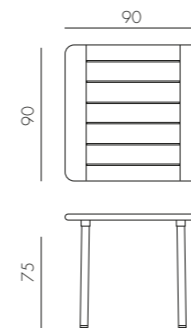

11,7 kg
n. pz. 1



BIANCO verniciato bianco 42053.00.000	ANTRACITE verniciato antracite 42052.02.000	CAFFÈ verniciato caffè 42057.05.000	TORTORA verniciato tortora 42059.10.000
---	---	---	---

DurelTOP - polipropilene
alluminio

LOTO RELAX 95

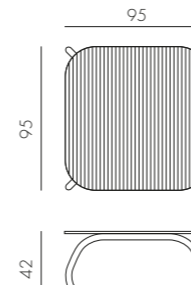

27 kg
n. pz. 1



ANTRACITE verniciato antracite 44752.02.000	BIANCO verniciato bianco 44753.00.000
---	---

vetro
alluminio

LOTO RELAX 60

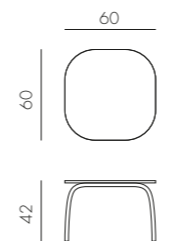

7 kg
n. pz. 1



ANTRACITE verniciato antracite 44652.00.303	BIANCO verniciato bianco 44653.00.301
---	---

laminato
alluminio

BASE IBISCO

PIANI Ø60 - Ø70 - Ø80 - 60X60 - 70X70 - 80X80

alluminio

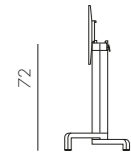
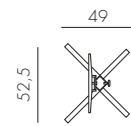

6 kg
n. pz. 1



BASE IBISCO HIGH

PIANI Ø60 - Ø70 - 60X60 - 70X70

alluminio

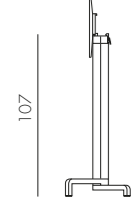
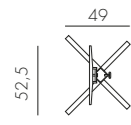

6,7 kg
n. pz. 1



BASE FIORE

PIANI Ø60 - Ø70 - Ø80 - 60X60 - 70X70 - 80X80

alluminio

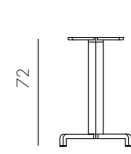
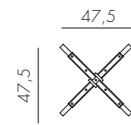

5 kg
n. pz. 1



■ trattamento speciale per ambienti ad alto tasso salino - special treatment for high salinity environments - traitement spécial pour les environnements a haute salinité - Sonderbehandlung für Ambiente mit hohem Salzgehalt - tratamiento especial para ambientes con alta salinidad - tratamiento especial para ambientes con alto teor de sal - yüksek tuza maruz kalan alanlar için özel bakım - Специальная обработка для среды с высоким содержанием соли

Qualora il prodotto venga posizionato in ambienti altamente salini raccomandiamo di scegliere una base con trattamento speciale. If the product is placed in highly salty environments, we recommend choosing a base with a special treatment. Si le produit est placé dans des environnements a haute salinite, nous recommandons de choisir une base avec un traitement spécial. Wenn das Produkt in der Umgebung mit hohem Salzgehalt platziert ist, empfehlen wir, eine Basis mit Sonderbehandlung zu wählen. Si el producto se coloca en ambientes con alta salinidad, recomendamos elegir una base con un tratamiento especial. Se o produto for exposto em ambientes com alto teor de salinidade, recomendamos a escolha de uma base com tratamento especial. Ürünün, salinitesi yüksek olan ortamlarda kullanılması durumunda, özel muamele görmüş versiyonun seçilmesi tavsiye olunur. Если изделие будет использоваться в среде с высоким содержанием соли, рекомендуется выбрать основание со специальной обработкой.

BASE FIORE HIGH

PIANI Ø60 - Ø70 - 60X60 - 70X70

alluminio

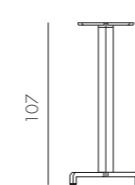
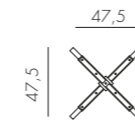

5,7 kg
n. pz. 1

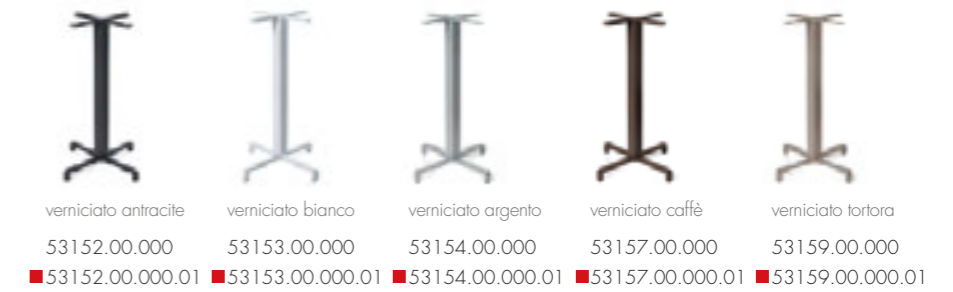

BASE SCUDO

PIANI Ø60 - Ø70 - Ø80 - 60X60 - 70X70 - 80X80

alluminio

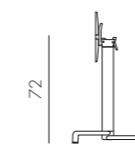
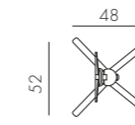

5,8 kg
n. pz. 1



BASE SCUDO HIGH

PIANI Ø60 - Ø70 - 60X60 - 70X70

alluminio

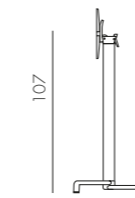
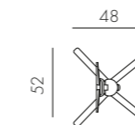

6,7 kg
n. pz. 1



■ trattamento speciale per ambienti ad alto tasso salino - special treatment for high salinity environments - traitement spécial pour les environnements a haute salinité - Sonderbehandlung für Ambiente mit hohem Salzgehalt - tratamiento especial para ambientes con alta salinidad - tratamiento especial para ambientes con alto teor de sal - yüksek tuza maruz kalan alanlar için özel bakım - Специальная обработка для среды с высоким содержанием соли

Qualora il prodotto venga posizionato in ambienti altamente salini raccomandiamo di scegliere una base con trattamento speciale. If the product is placed in highly salty environments, we recommend choosing a base with a special treatment. Si le produit est placé dans des environnements a haute salinite, nous recommandons de choisir une base avec un traitement spécial. Wenn das Produkt in der Umgebung mit hohem Salzgehalt platziert ist, empfehlen wir, eine Basis mit Sonderbehandlung zu wählen. Si el producto se coloca en ambientes con alta salinidad, recomendamos elegir una base con un tratamiento especial. Se o produto for exposto em ambientes com alto teor de salinidade, recomendamos a escolha de uma base com tratamento especial. Ürünün, salinitesi yüksek olan ortamlarda kullanılması durumunda, özel muamele görmüş versiyonun seçilmesi tavsiye olunur. Если изделие будет использоваться в среде с высоким содержанием соли, рекомендуется выбрать основание со специальной обработкой.

BASE SCUDO DOUBLE PIANI 110X170 - 120X80

alluminio

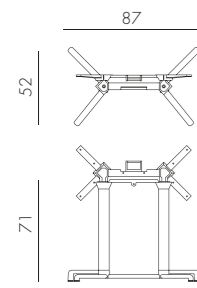

verniciato antracite	verniciato argento	verniciato tortora
54352.00.000	54354.00.000	54359.00.000
■54352.00.000.01	■54354.00.000.01	■54359.00.000.01

8,7 kg
n. pz. 1



BASE CALICE ALU PIANI Ø60 - Ø70 - Ø80 - 60X60 - 70X70 - 80X80

alluminio

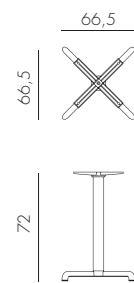

verniciato antracite	verniciato bianco	verniciato argento	verniciato tortora
52652.00.000	52653.00.000	52654.00.000	52659.00.000
■52652.00.000.01	■52653.00.000.01	■52654.00.000.01	■52659.00.000.01

4,5 kg
n. pz. 1

BASE CALICE ALU HIGH PIANI Ø60 - Ø70 - 60X60 - 70X70

alluminio

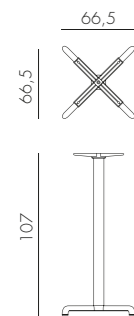

verniciato antracite	verniciato bianco	verniciato argento	verniciato tortora
52752.00.000	52753.00.000	52754.00.000	52759.00.000
■52752.00.000.01	■52753.00.000.01	■52754.00.000.01	■52759.00.000.01

5,5 kg
n. pz. 1

■ trattamento speciale per ambienti ad alto tasso salino - special treatment for high salinity environments - traitement spécial pour les environnements a haute salinité - Sonderbehandlung für Ambiente mit hohem Salzgehalt - tratamiento especial para ambientes con alta salinidad - tratamento especial para ambientes com alto teor de sal - yüksek tuza maruz kalan alanlar için özel bakım - Специальная обработка для среды с высоким содержанием соли

Qualora il prodotto venga posizionato in ambienti altamente salini raccomandiamo di scegliere una base con trattamento speciale. If the product is placed in highly salty environments, we recommend choosing a base with a special treatment. Si le produit est placé dans des environnements a haute salinite, nous recommandons de choisir une base avec un traitement spécial. Wenn das Produkt in der Umgebung mit hohem Salzgehalt platziert ist, empfehlen wir, eine Basis mit Sonderbehandlung zu wählen. Si el producto se coloca en ambientes con alta salinidad, recomendamos elegir una base con un tratamiento especial. Se o produto for exposto em ambientes com alto teor de salinidade, recomendamos a escolha de uma base com tratamento especial. Ürünün, salinitesi yüksek olan ortamlarda kullanılması durumunda, özel muamele görmüş versiyonun seçilmesi tavsiye olunur. Если изделие будет использоваться в среде с высоким содержанием соли, рекомендуется выбрать основание со специальной обработкой.

BASE FLUTE PIANI Ø60 - Ø70

alluminio

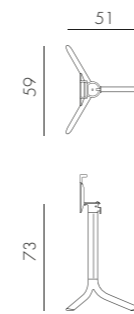

verniciato antracite	verniciato bianco	verniciato argento	verniciato tortora
55652.00.000	55653.00.000	55654.00.000	55659.00.000
■55652.00.000.01	■55653.00.000.01	■55654.00.000.01	■55659.00.000.01

4,9 kg
n. pz. 1



BASE BREAK PIANI Ø60 - Ø70

alluminio

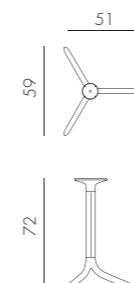

verniciato antracite	verniciato bianco	verniciato argento	verniciato tortora
55852.00.000	55853.00.000	55854.00.000	55859.00.000
■55852.00.000.01	■55853.00.000.01	■55854.00.000.01	■55859.00.000.01

4,3 kg
n. pz. 1

■ trattamento speciale per ambienti ad alto tasso salino - special treatment for high salinity environments - traitement spécial pour les environnements a haute salinité - Sonderbehandlung für Ambiente mit hohem Salzgehalt - tratamiento especial para ambientes con alta salinidad - tratamento especial para ambientes com alto teor de sal - yüksek tuza maruz kalan alanlar için özel bakım - Специальная обработка для среды с высоким содержанием соли

Qualora il prodotto venga posizionato in ambienti altamente salini raccomandiamo di scegliere una base con trattamento speciale. If the product is placed in highly salty environments, we recommend choosing a base with a special treatment. Si le produit est placé dans des environnements a haute salinite, nous recommandons de choisir une base avec un traitement spécial. Wenn das Produkt in der Umgebung mit hohem Salzgehalt platziert ist, empfehlen wir, eine Basis mit Sonderbehandlung zu wählen. Si el producto se coloca en ambientes con alta salinidad, recomendamos elegir una base con un tratamiento especial. Se o produto for exposto em ambientes com alto teor de salinidade, recomendamos a escolha de uma base com tratamento especial. Ürünün, salinitesi yüksek olan ortamlarda kullanılması durumunda, özel muamele görmüş versiyonun seçilmesi tavsiye olunur. Если изделие будет использоваться в среде с высоким содержанием соли, рекомендуется выбрать основание со специальной обработкой.

PIANI LAMINATO

BASE CALICE - SCUDO - SCUDO DOUBLE - IBISCO - FIORE - FLUTE - BREAK - BASE CLIP

			GRIGIO	BIANCO	CAFFÈ *	ANTRACITE *	CEMENTO	TORTORA
		1,2 cm						
piano Ø60		4,5 kg n. pz. 2	30616.10.300	30616.10.301	30616.10.302	30616.10.303	30616.10.305	30616.10.310
piano Ø70		6,2 kg n. pz. 2	30617.10.300	30617.10.301	30617.10.302	30617.10.303	30617.10.305	30617.10.310
piano Ø80		8,1 kg n. pz. 2	30618.10.300	30618.10.301	30618.10.302	30618.10.303	30618.10.305	30618.10.310
piano 60x60		5,8 kg n. pz. 2	30606.10.300	30606.10.301	30606.10.302	30606.10.303	30606.10.305	30606.10.310
piano 70x70		7,9 kg n. pz. 2	30607.10.300	30607.10.301	30607.10.302	30607.10.303	30607.10.305	30607.10.310
piano 80x80		10,9 kg n. pz. 2	30608.10.300	30608.10.301	30608.10.302	30608.10.303	30608.10.305	30608.10.310
piano 110x70		12,4 kg n. pz. 2	30621.10.300	30621.10.301				
piano 120x80		15,5 kg n. pz. 2	30620.10.300	30620.10.301				

			LEGNO	CORTEN *
piano Ø60		4,5 kg n. pz. 2	30616.10.311	30616.10.312
piano Ø70		6,2 kg n. pz. 2	30617.10.311	30617.10.312
piano Ø80		8,1 kg n. pz. 2	30618.10.311	30618.10.312
piano 60x60		5,8 kg n. pz. 2	30606.10.311	30606.10.312
piano 70x70		7,9 kg n. pz. 2	30607.10.311	30607.10.312
piano 80x80		10,9 kg n. pz. 2	30608.10.311	30608.10.312

* Posizionare in zona d'ombra - Only use table tops in shaded areas - Plateaux qui doivent être utilisés uniquement dans des zones ombragées - Tischplatten nur für beschatteten Einsatzbereich - Utilizar estos tableros sólo en áreas sombreadas - Colocar em local sombreado - Gölge alana koyun - Ставить в тени

PIANI WERZALIT-TOPALIT

BASE CALICE - SCUDO - SCUDO DOUBLE - IBISCO - FIORE - FLUTE - BREAK - BASE CLIP

				BIANCO	ARGENTO	WICKER *
		con inserti with inserts avec inserts mit einsätzen	con insertos com cavilhas çengelli с вставками			
piano Ø60		sp. 2,6 cm	4 kg n. pz. 1	30016.10.190	30016.10.197	30016.10.198
piano Ø70		sp. 2,6 cm	4,9 kg n. pz. 1	30017.10.190	30017.10.197	30017.10.198
piano Ø80		sp. 2,6 cm	6,8 kg n. pz. 1	30018.10.190	30018.10.197	30018.10.198
piano 60x60		sp. 3 cm	4,9 kg n. pz. 1	30006.10.190	30006.10.197	30006.10.198
piano 70x70		sp. 3 cm	7,2 kg n. pz. 1	30007.10.190	30007.10.197	30007.10.198
piano 80x80		sp. 3,3 cm	9,2 kg n. pz. 1	30008.10.190	30008.10.197	30008.10.198
piano 110x70		sp. 3 cm	10,8 kg n. pz. 1	30021.10.190	30021.10.197	
piano 120x80		sp. 3,3 cm	15 kg n. pz. 1	30020.10.190	30020.10.197	

PIANI WERZALIT-TOPALIT

				BIANCO	ARGENTO	WICKER *
		senza agganci without hooks sans accrochements ohne Tragegriffe	sin enganches sem ganchos Werzalitablalar, çengelsiz без креплений			
piano Ø60		sp. 2,6 cm	4,3 kg n. pz. 1	1801430.00.190	1801430.00.197	1801430.00.198
piano Ø70		sp. 2,6 cm	5,1 kg n. pz. 1	1801630.00.190	1801630.00.197	1801630.00.198
piano Ø80		sp. 2,6 cm	6,9 kg n. pz. 1	1801930.00.190	1801930.00.197	1801930.00.198
piano 60x60		sp. 3 cm	5 kg n. pz. 1	1801530.00.190	1801530.00.197	1801530.00.198
piano 70x70		sp. 3 cm	6,7 kg n. pz. 1	1801730.00.190	1801730.00.197	1801730.00.198
piano 80x80		sp. 3,3 cm	9,5 kg n. pz. 1	1801830.00.190	1801830.00.197	1801830.00.198
piano 110x70		sp. 3 cm	10,8 kg n. pz. 1	1802130.00.190	1802130.00.197	
piano 120x80		sp. 3,3 cm	15 kg n. pz. 1	1802030.00.190	1802030.00.197	

* Posizionare in zona d'ombra - Only use table tops in shaded areas - Plateaux qui doivent être utilisés uniquement dans des zones ombragées - Tischplatten nur für beschatteten Einsatzbereich - Utilizar estos tableros sólo en áreas sombreadas - Colocar em local sombreado - Gölge alana koyun - Ставить в тени

PIANI DURELTOP

BASE CALICE - SCUDO - IBISCO - FIORE - BASE CLIP

	BIANCO	ANTRACITE *	GRIGIO	CAFFÈ *	TORTORA
<p>piano 70x70</p>  <p>sp. 2,2 cm 3,9 kg n. pz. 1</p>	30207.00.400	30207.00.402	30207.00.403	30207.00.405	30207.00.410
<p>piano 80x80</p>  <p>sp. 3,2 cm 7,2 kg n. pz. 1</p>	30208.00.400	30208.00.402	30208.00.403	30208.00.405	30208.00.410

POLO 70X70 DURELTOP

DurelTOP - polipropilene alluminio

 <p>70</p>  <p>72</p> <p>8,4 kg n. pz. 1</p>	 <p>DurelTOP BIANCO BIANCO anodizzato argento 50750.00.400</p>	 <p>DurelTOP GRIGIO ANTRACITE anodizzato argento 50750.02.403</p>	 <p>DurelTOP GRIGIO GRIGIO anodizzato argento 50750.03.403</p>	 <p>DurelTOP ANTRACITE * ANTRACITE verniciato antracite 50752.02.402</p>
---	--	---	--	--











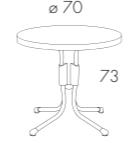

POLO 80X80 DURELTOP

DurelTOP - polipropilene alluminio

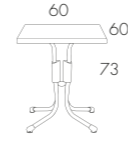
 <p>80</p>  <p>72</p> <p>8,6 kg n. pz. 1</p>	 <p>DurelTOP BIANCO BIANCO anodizzato argento 50850.00.400</p>	 <p>DurelTOP GRIGIO ANTRACITE anodizzato argento 50850.02.403</p>	 <p>DurelTOP GRIGIO GRIGIO anodizzato argento 50850.03.403</p>	 <p>DurelTOP ANTRACITE * ANTRACITE verniciato antracite 50852.02.402</p>
--	---	--	---	---

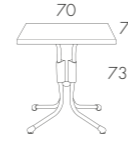
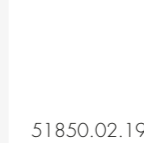
* Posizionare in zona d'ombra - Only use table tops in shaded areas - Plateaux qui doivent être utilisés uniquement dans des zones ombragées - Tischplatten nur für beschatteten Einsatzbereich - Utilizar estos tableros sólo en áreas sombreadas - Colocar em local sombreado - Gölge alana koyun - Ставить в тени

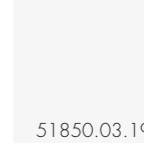
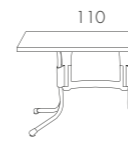
POLO WERZALIT-TOPALIT

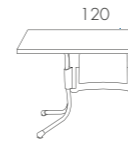
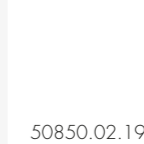
		WERZALIT-TOPALIT BIANCO bianco anodizzato	WERZALIT-TOPALIT ARGENTO antracite anodizzato	WERZALIT-TOPALIT ARGENTO grigio anodizzato
<p>POLO Ø60</p>  <p>8,6 kg n. pz. 1</p>		51650.00.190	51650.02.197	51650.03.197
<p>POLO Ø70</p>  <p>9 kg n. pz. 1</p>		51750.00.190	51750.02.197	51750.03.197
<p>POLO Ø80</p>  <p>11,1 kg n. pz. 1</p>		51850.00.190	51850.02.197	51850.03.197
<p>POLO 60X60</p>  <p>8,6 kg n. pz. 1</p>		50650.00.190	50650.02.197	50650.03.197
<p>POLO 70X70</p>  <p>10,2 kg n. pz. 1</p>		50750.00.190	50750.02.197	50750.03.197
<p>POLO 80X80</p>  <p>12,7 kg n. pz. 1</p>		50850.00.190	50850.02.197	50850.03.197
<p>POLO 110X70</p>  <p>16,7 kg n. pz. 1</p>		51150.00.190	51150.02.197	51150.03.197
<p>POLO 120X80</p>  <p>20,1 kg n. pz. 1</p>		51250.00.190	51250.02.197	51250.03.197

CUSCINO NET BENCH

tessuto

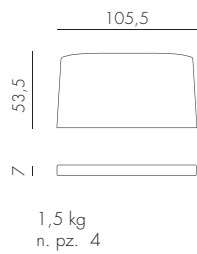

CUSCINO NET

tessuto



CUSCINO NET RELAX

tessuto

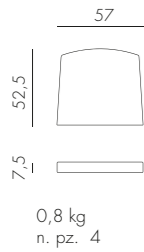

CUSCINO PASSEPARTOUT

tessuto

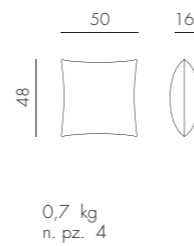

CUSCINO SHELL (NET RELAX)

tessuto

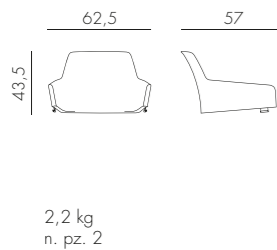

CUSCINO TRILL **new**

tessuto

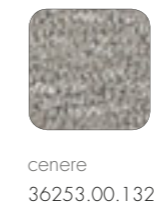

CUSCINO SEDUTA ARIA

tessuto

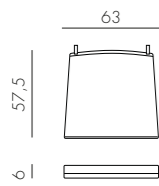

0,8 kg
n. pz. 4



CUSCINO ARREDO ARIA

tessuto

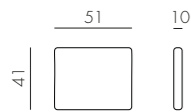

0,5 kg
n. pz. 4



CUSCINO FIT ARIA

tessuto

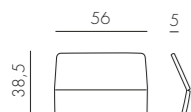

0,5 kg
n. pz. 4



CUSCINO ACQUAMARINA

tessuto

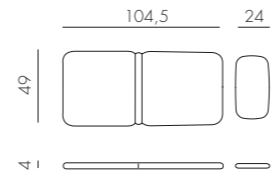

0,9 kg
n. pz. 4

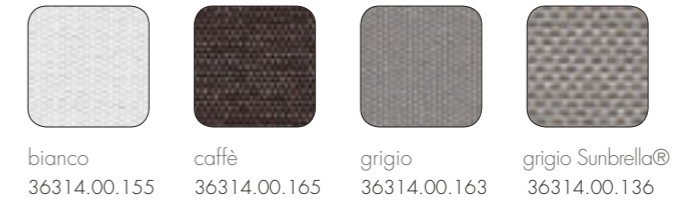

CUSCINO DARSENA

tessuto

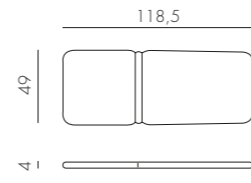

0,8 kg
n. pz. 4



CUSCINO EDEN

tessuto

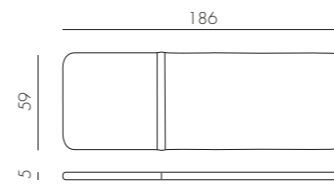

1,8 kg
n. pz. 4



CLEAN RESIN

detergente 0,5 l n. pz. 12



39101.00.000

CLEAN RESIN SPECIAL

detergente 5 l n. pz. 1

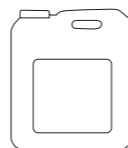

39102.00.000

Detergente specifico per la pulizia dei lettini Alfa, Omega e Atlantico
 Detergent specific for the cleaning of our sunloungers Alfa, Omega and Atlantico
 Détergent spécifique pour nettoyer nos lits Alpha, Omega et Atlantico
 Reinigungsmittel speziell geeignet für die Reinigung unseren Liegen Alpha, Omega und Atlantico
 Detergente para a limpeza de nuestra camas Alfa, Omega y Atlantico
 Detergente para a limpeza de nossas camas Alpha, Omega e Atlantico
 Alfa ve Omega ve Atlantico kumaşı için özel sıvı deterjan
 Специальное моющее средство для лежаков алфа и omega и atlantico

materiali
materials

polipropilene

Polipropilene trattato anti-UV e colorato in massa. Riciclabile al 100%.
 Polypropylene with UV additives and is uniformly colored. 100% Recyclable resin.
 Polypropylène traité anti-UV et coloré dans la masse. Résine recyclable 100%.
 UV-beständigem Polypropylen, voll durchgefärbt. 100% Recyclebarer Kunststoff.
 Polipropileno tratado anti UV y teñido en masa. Resina reciclable 100%.
 Polipropileno com tratamento anti-UV colorido na totalidade. Resina reciclável 100%.
 Işığa dayanıklı ve boyalı olarak granül çekilmiş %100 geri dönüşümlü polipropilen kompozit hammadde.
 Полипропилен с обработкой анти-УФ, окрашенное в массу. На 100% пригодно для вторичной переработки.



BIANCO .00

GRIGIO .03

ANTRACITE .02



BURRO .28

TORTORA .10

TABACCO .53

CAFFE' .05



CELESTE .39

OTTANIO .49

SALICE .04

AGAVE .16



SENAPE .56

CORALLO .75

ROSSO .07

ROSSO .07

polipropilene fiberglass

Polipropilene fiberglass trattato anti-UV e colorato in massa. Resina riciclabile al 100%.
 Uniformly colored fiberglass polypropylene resins with uv additives. 100% Recyclable resin.
 Polypropylène fiberglass traité anti-uv et coloré dans la masse. Résine recyclable 100%.
 UV-beständigem fiberglass Polypropylen, voll durchgefärbt. 100% Recyclebarer Kunststoff.
 Polipropileno fiberglass tratado anti UV y teñido en masa. Resina reciclable 100%.
 Polipropileno fiberglass com tratamento anti-UV colorido na totalidade. Resina reciclável 100%.
 Işığa dayanıklı ve boyalı olarak granül çekilmiş %100 geri dönüşümlü cam elyaf katkılı polipropilen kompozit hammadde.
 Полипропилен фиброволокно с обработкой анти-УФ, окрашенное в массу. На 100% пригодно для вторичной переработки.

durelTOP

DurelTOP è un sistema innovativo di produzione di piani per tavoli studiati per raggiungere i più elevati livelli di praticità, resistenza, robustezza ed eleganza. I piani DurelTOP sono ad alto spessore, formati da un doppio strato tamburato perfettamente chiuso. Prodotti in polipropilene di prima qualità, sono inalterabili all'acqua, resistenti al sole e facili da pulire. DurelTOP è il risultato di una lunga ricerca tecnologica e dell'esperienza decennale nella lavorazione delle materie plastiche della NARDI, da sempre all'avanguardia nell'ambiente contract e giardino.

The DurelTOP is an innovative new system in the production of tabletops developed to reach the highest levels of practicality, resistance, and elegance. The DurelTOP tabletops have a greater thickness, formed by a double layer enclosure perfectly closed. Produced in first quality polypropylene, they are resistant to water, resistant to sunlight, and are easy to clean. DurelTOP is a result of a decade's long research and development in plastics by Nardi, always a leader in the contract and garden sectors.

DurelTOP est un système innovateur de production de plateaux de tables, il est étudié pour retrouver le meilleur niveau de pratique de résistance et d'élégance. Les plateaux DurelTOP sont très épais, formés de doubles couches parfaitement finies. Ce sont des produits en polypropylène de première qualité, ils sont inaltérables à l'eau, résistent au soleil et faciles à nettoyer. DurelTOP est le résultat d'une longue recherche technologique et une expérience décennale dans le travail des matières plastique de la Sté NARDI, toujours à l'avant-garde dans le secteur du contract et jardin.

DurelTOP ist ein neu entwickeltes System für die Produktion von Tischplatten, um ein Höchstmaß an Funktionalität, Widerstandsfähigkeit und Eleganz zu erreichen. Durch das innen verstärkte "Zwei-Schichten-Hohlraum-System" erreicht die DurelTOP Tischplatte einen stärkeren Querschnitt und damit ein Höchstmaß an Festigkeit. Hergestellt aus hochwertigem Qualitätspolypropylen ist sie resistent gegen Wasser und Sonnenlicht und dabei leicht zu reinigen. DurelTOP ist das Ergebnis von 10 Jahren Forschung und Entwicklung auf dem Kunststoffsektor durch Nardi, immer der führende im Bereich Contract- und Gartenmöbel.

tessuto acrilico

Fibra acrilica 100% tinto filo. Trattamento antimacchia, antimuffa. Solidità alla luce 5/8. Sfoderabile/zip, lavabile a 30°.
 100% yarn dyed acrylic. Dirt repellent and anti-mould treatment. 5/8 light fastness. Removeable/zip, washable at 30°.
 100% fibre acrylique teintée en fils. Traitement anti-taches et anti-moisissure. Résistance à la lumière 5/8. Déhoussable/zip. Lavable à 30°.
 100% garngefärbtes Acryl-Gewebe. Gegen Flecken und Schimmel Behandlung. Lichtechtheit 5/8. Abziehbarer/zip. Waschbar bei 30°.

DurelTOP es un nuevo sistema de fabricación de tableros de mesa estudiado para alcanzar los mas altos niveles de practicidad, resistencia, robustez y elegancia. Los tableros DurelTOP de gran solidez, estan formados por una doble capa perfectamente unida y sellada. Fabricados en polipropileno de primera calidad son inalterables al agua, resistentes al sol y de fácil limpieza. DurelTOP es el resultado de una prolongada investigación tecnológica y de la experiencia acumulada en los mas de diez años que Nardi lleva produciendo materias plasticas, siempre innovando en ambientes contract y jardín.

DurelTOP é um sistema de inovação da produção de tampos de mesa concebidos para atingir a máxima resistência,práticos e elegantes. Os tampos de mesa DurelTOP são formados poruma camada dupla e perfeitamente unida. Produzidos em polipropileno de primeira qualidade, são resistentes ao sol e fáceis de limpar. DurelTOP é o resultado de uma longa investigação tecnológica em materiais plásticos da Nardi, leader em mobiliário de jardim.

DurelTOP, masa tablalarının üretiminde kullanılan yeni bir sistem olup, yüksek seviyede pratiklik, direnç ve de şıklık sunmak amacıyla geliştirilmiştir. DurelTOP masa tablaları fevkalade bir inceliğe sahip olup, kusursuz kapanan çift tabaka çevirme sistemiyle oluşturulmuştur. Nitelikli çamsakızından üretilmiş olup, suya ve güneş ışığına karşı dirençli ve temizlenmesi kolaydır. DurelTOP sistemini Contract ve de Bahçe sektöründe her zaman lider olan Nardi'nin uzun araştırmalarının sonucundan doğan, plastikte gelişim olarak adlandırabiliriz.

DurelTOP — это инновационная система производства столешниц, позволяющая изготавливать практичные, прочные, крепкие и элегантные столешницы. Столешницы DurelTOP обладают высокой плотностью и состоят из двойной панели с мелкопустотным заполнением, полностью закрытой. Изделия из полипропилен высокого качества устойчивы к воде, солнцу и просты в уходе. DurelTOP — это результат многолетних технологических исследований и десятилетнего опыта NARDI в обработке пластмасс, лидера в производстве садовой мебели и контрактном секторе.

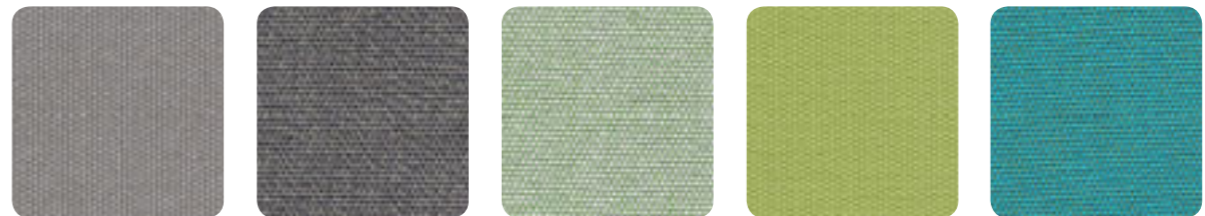
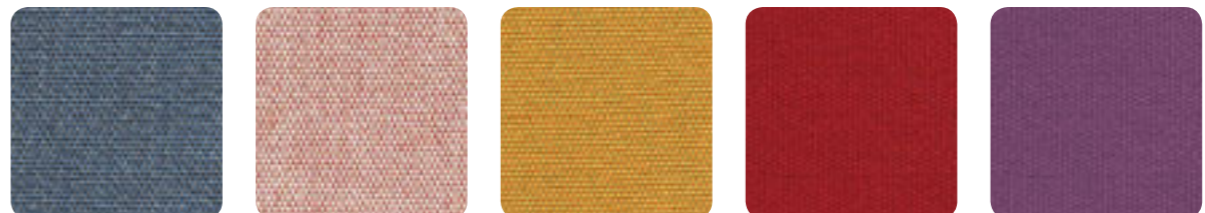

100% hilo teñido acrílico. Protección antimanchas, antimoho. Solidez a la luz 5/8. Desenfundable/zip. Lavable a 30°.
 100% fibra acrílica tingida com fio. Tratamento antimancha e antimoho. Resistência à luz 5/8. Removível/zip. Lavável a 30°.
 %100 akrilik elyaf boyalı iplik. Leke itici, küf önleyici ile muamele edilmiş. Işık haslığı 5/8. Çıkarılabilir/fermuar, 30°de yıkanabilir.
 Акриловое волокно 100% окрашенное в пряже. Пятноустойчивая и противогрибковая обработка. Светостойкость 5/8. Съемная обивка/с молнией, стирать при 30°.

grigio .163
240 gr/m²grey stone .064
240 gr/m²the verde .071
240 gr/m²lime .061
240 gr/m²sardinia .072
240 gr/m²denim .070
240 gr/m²rosa quarzo .066
240 gr/m²senape .069
240 gr/m²cherry .065
240 gr/m²melanzana .068
190 gr/m²

tessuto acrilico stampato



Fibra acrilica 100% stampa digitale. Solidità alla luce 6. Sfoderabile/zip, lavabile a 30°. 100% acrylic fiber with digital print. 6 light fastness. Removeable/zip, washable at 30°. 100% fibre acrylique impression numérique. Résistance à la lumière 6. Déhoussable/zip. Lavable à 30°. 100% Acrylfaser mit Digitaldruck. Lichtechtheit 6. Abziehbarer/zip. Waschbar bei 30°.



tropical .081
190 gr/m²

tessuto acrilico Sunbrella®



100% fibra acrilica SUNBRELLA® tinto in massa. Trattamento idrorepellente, antimacchia, antimuffa. Solidità alla luce 8/8. Sfoderabile/zip, lavabile a 40°. 100% SUNBRELLA® acrylic fiber mass dyed. Water repellent treatment, dirt repellent and anti-mould treatment. 8/8 light fastness. Removeable/zip, washable at 40°. 100% fibre acrylique SUNBRELLA® teintée en masse. Traitement imperméable, anti-taches et anti-moisissure. Résistance à la lumière 8/8. Déhoussable/zip. Lavable à 40°. 100% fasergefärbtes Acryl SUNBRELLA®. Wasserabweisend Behandlung, gegen Flecken und Schimmel Behandlung. Lichtechtheit 8/8. Abziehbarer/zip. Waschbar bei 40°.

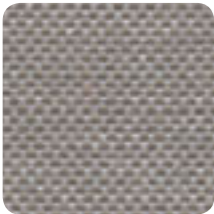

grigio Sunbrella® .136
275 gr/m²



canvas Sunbrella® .141
275 gr/m²



adriatic Sunbrella® .142
260 gr/m²

cuscino Trill termoformato



TESSUTO SUNBRELLA® TERRY: 76% fibra acrilica SUNBRELLA® tinto in massa e 24% poliestere. Trattamento antimacchia, antimuffa. Solidità alla luce 7/8. Senza cuciture. Lavabile a 30°. Imbottitura: poliuretano espanso rivestito da membrana TPU waterproof. Densità 40 kg/m³. SUNBRELLA® TERRY FABRIC: 76% SUNBRELLA® acrylic fiber mass dyed and 24% polyester. Dirt repellent and anti-mould treatment. 7/8 light fastness. Seamless. Washable at 30°. Padding: polyurethane foam with a TPU waterproof membrane. Density 40 kg/m³. SUNBRELLA® TERRY TISSU :76% fibre acrylique SUNBRELLA® teintée en masse et 24% polyester. Traitement anti-taches et anti-moisissure. Résistance à la lumière 7/8. Sans couture. Lavable à 30°. Rembourrage: mousse polyuréthane revêtu d'une membrane TPU imperméable. Densité 40 kg/m³. SUNBRELLA® TERRY GEWEBE: 76% fasergefärbtes Acryl SUNBRELLA® und 24% Polyester. Gegen Flecken und Schimmel Behandlung. Lichtechtheit 7/8. Ohne Nähte. Waschbar bei 30°. Polsterung: Polyurethanschäum mit einer wasserdichten TPU-Membran abgedeckt. Dichte 40 kg/m³.



cenere .132
550 gr/m²

100% fibra acrilica impresión digital. Solidez a la luz 6. Desenfundable/zip. Lavable a 30°. 100% fibra acrilica estampa digital. Resistência à luz 6. Removível/zip. Lavável a 30°. %100 dijital baskı akrilik elyaf. Işığa dayanıklılık 6. Çıkarılabilir kılıf/fermuar, 30°de yıkanabilir. 100% акриловое волокно с цифровым рисунком, окрашенное в процессе производства. Светостойкость 6. Съемная ткань/на молнии, стирка при 30°.

100% fibra acrilica SUNBRELLA® tintada en masa. Tratamiento por la repelencia al agua, protección antimanchas, antimoho. Solidez a la luz 8/8. Desenfundable/zip. Lavable a 40°. 100% fibra acrilica SUNBRELLA® tingida em massa. Tratamento hidrorrepelente, antimancha e antimoho. Resistência à luz 8/8. Removível/zip. Lavável a 40°. %100 akrilik elyaf SUNBRELLA® çözelti halindeyken boyanmış. Su itici, leke itici, küf önleyici ile muamele edilmiş. Işık haslığı 8/8. Çıkarılabilir/fermuar, 40°de yıkanabilir. 100% акриловое волокно SUNBRELLA®, окрашенное в массе. Водоотталкивающая, пятноустойчивая и противогрибковая обработка. Светостойкость 8/8. Съемная обивка/с молнией, стирать при 40°.

tessuto 100% Olefin



100% Olefin tinto in massa. Trattamento antimacchia, antimuffa. Solidità alla luce 7/8. Sfoderabile/zip, lavabile a 40°. 100% Olefin mass dyed. Dirt repellent and anti-mould treatment. 7/8 light fastness. Removeable/zip, washable at 40°. 100% Olefin teintée en masse. Traitement anti-taches et anti-moisissure. Résistance à la lumière 7/8. Déhoussable/zip. Lavable à 40°. 100% fasergefärbtes Olefin. Gegen Flecken und Schimmel Behandlung. Lichtechtheit 7/8. Abziehbarer/zip. Waschbar bei 40°.



bianco .155
190 gr/m²



caffè .165
190 gr/m²

tessuto 100% Olefin cuscino Eden



100% Olefin tinto in massa. Trattamento con resina poliuretanic/acrilica, idrorepellente. Solidità alla luce 7/8. Sfoderabile/zip, lavabile a 40°. 100% Olefin mass dyed. Treatment with polyurethane / acrylic resin, water-repellent. 7/8 light fastness. Removeable/zip, washable at 40°. 100% Olefin teintée en masse. Traitement avec une résine de polyuréthane / acrylique, imperméable. Résistance à la lumière 7/8. Déhoussable/zip. Lavable à 40°. 100% fasergefärbtes Olefin. Behandlung mit Polyurethan-Harz / Acryl, wasserabweisend. Lichtechtheit 7/8. Abziehbarer/zip. Waschbar bei 40°.



écru .160
220 gr/m²



blu .076
220 gr/m²

imbottitura

CUSCINO NET BENCH - CUSCINO NET RELAX - CUSCINO NET - CUSCINO FIT ARIA - CUSCINO ACQUAMARINA - CUSCINO DARSENA

Poliuretano espanso. Densità 28 kg/m³. Polyurethane foam. Density 28 kg/m³. Mousse polyuréthane. Densité 28 kg/m³. Polyurethanschäum. Dichte 28 kg/m³. Espuma de poliuretano. Densidad 28 kg/m³. Espuma de poliuretano. Densidade 28 kg/m³. Poliüretan köpük. Yoğunluk 28 kg/m³. Пенополиуретан. Плотность 28 кг/м³.

CUSCINO SEDUTA ARIA

Poliuretano espanso. Densità 25 kg/m³. Polyurethane foam. Density 25 kg/m³. Mousse polyuréthane. Densité 25 kg/m³. Polyurethanschäum. Dichte 25 kg/m³. Espuma de poliuretano. Densidad 25 kg/m³. Espuma de poliuretano. Densidade 25 kg/m³. Poliüretan köpük. Yoğunluk 25 kg/m³. Пенополиуретан. Плотность 25 кг/м³.

CUSCINO SHELL NET RELAX

Poliuretano espanso su struttura rigida di polipropilene. Densità 70 kg/m³. Polyurethane foam over solid polypropylene frame. Density 70 kg/m³. Mousse polyuréthane sur structure rigide de polypropylène. Densité 70 kg/m³. Polyurethanschäum auf steifer Polypropylen-gestell. Dichte 70 kg/m³. Espuma de poliuretano sobre estructura rígida de polipropileno. Densidad 70 kg/m³. Espuma de poliuretano sobre estrutura rígida de polipropileno. Densidade 70 kg/m³. Sert polipropilen gövde üzerinde poliüretan köpük minder. Yoğunluk 70 kg/m³. Пенополиуретан. на жесткой конструкции из полипропилена. Плотность 70 кг/м³.

CUSCINO PASSEPARTOUT

Fibra di poliestere. Polyester fiber. Fibre de polyester. Polyesterfasern. Fibras de poliéster. Fibras de poliéster. Polyester elyaf. Обивка из полиэстера.

100% Olefin tintada en masa. Protección antimanchas, antimoho. Solidez a la luz 7/8. Desenfundable/zip. Lavable a 40°. 100% Olefin tingida em massa. Tratamento antimancha e antimoho. Resistência à luz 7/8. Removível/zip. Lavável a 40°. %100 Olefin çözelti halindeyken boyanmış. Leke itici, küf önleyici ile muamele edilmiş. Işık haslığı 7/8. Çıkarılabilir/fermuar, 40°de yıkanabilir. 100% Olefin, окрашенный в массе. Пятноустойчивая и противогрибковая обработка. Светостойкость 7/8. Съемная обивка/с молнией, стирать при 40°.

100% Olefin tintada en masa. Tratamiento con resina de poliuretano / acrílico, repelente al agua. Solidez a la luz 7/8. Desenfundable/zip. Lavable a 40°. 100% Olefin tingida em massa. Tratamento com resina de poliuretano / acrílico, hidrorrepelente. Resistência à luz 7/8. Removível/zip. Lavável a 40°. 100% Olefin çözelti halindeyken boyanmış. Poliüretan reçine/akrilik ile muamele edilmiş, su itici. Işık haslığı 7/8. Çıkarılabilir/fermuar, 40°de yıkanabilir. 100% Olefin, окрашенный в массе. Обработка полиуретановым/акриловым полимером, водоотталкивающая. Светостойкость 7/8. Съемная обивка/с молнией, стирать при 40°.

tessuto sintetico

Tessuto in filo di poliestere rivestito in pvc. Fabric is made of a polyester fiber, with a pvc coating. Tissu en fil de polyester revêtu de pvc. Gewebe aus PVC-ummantelten Polyesterfasern. Tejido en hilo de poliester recubierto de pvc. Tecido de fibra polyester com cobertura pvc. PVC kaplı polyester elyaf tekstil. Ткань из полиэфирных нитей с покрытием из ПВХ.



bianco .107
tela 1x1

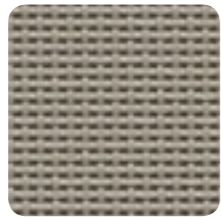

tortora .104
tela 1x1

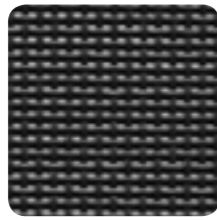

antracite .057
tela 1x1

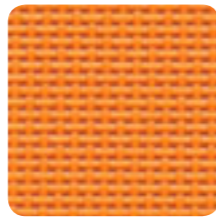

mandarino .083
tela 1x1

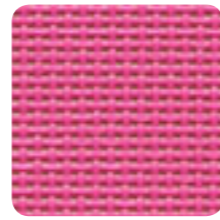

rosa .056
tela 1x1

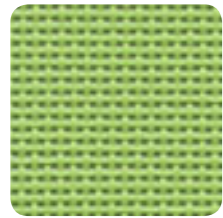

prato .084
tela 1x1

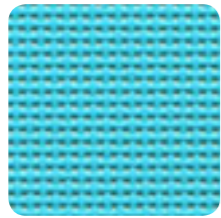

celeste .075
tela 1x1

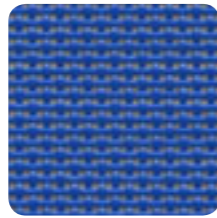

blu .102
tela 1x1



bianco .108
tela 2x2



beige .115
tela 2x2



tortora .124
tela 2x2

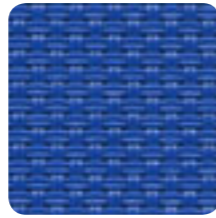

blu .112
tela 2x2



trama bianco .121



trama beige .078



trama caffè .117

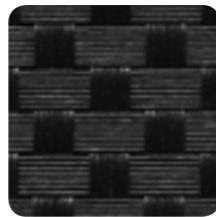

trama antracite .116

alluminio

verniciato

La verniciatura è a polvere di poliestere. The painting is with polyester powder. La peinture est à poudre de polyester. Die Epoxierung erfolgt mit Polyesterpulver. El pintado

se realiza con polvo de poliéster. O pó de poliester é usado para envernizar. Boyası polyester tozla yapılır. Окраска производится при помощи порошкового полиэстера.

verniciato - trattamento speciale

Trattamento speciale per ambienti ad alto tasso salino. Special treatment for high salinity environments. Traitement spécial pour les environnements a haute salinité. Sonderbehandlung für Ambiente mit hohem Salzgehalt. Tratamiento especial para ambientes con alta

salinidad. Tratamento especial para ambientes com alto teor de sal. Yüksek tuza maruz kalan alanlar için özel bakım. Специальная обработка для среды с высоким содержанием соли.

anodizzato

L'anodizzazione è un processo elettrolitico che aumenta l'ossidazione delle superfici prevenendo la corrosione con uno strato protettivo. Anodizing is an electrolytic procedure that increases oxidation of the surfaces, preventing corrosion with a protective layer. L'anodisation est un procédé électrolytique qui augmente l'oxydation des surfaces empêchant ainsi la corrosion grâce à une couche de protection. Die Eloxierung ist ein elektrolytischer Prozess, der die Oxydierung der Oberflächen erhöht und der Korrosion mit einer Schutzschicht vorbeugt. La anodización es un proceso electrolítico que aumenta el poder de oxidación de las superficies evitando de

esta manera la corrosión mediante una capa protectora. A anodização é um processo electrolítico que aumenta a oxidação das superfícies prevenindo a corrosão com uma camada protectora. Anodizing yüzeylerin oksitlenmesini artırır ve koruyucu bir tabakayla paslanmayı önleyen bir işlemdir. Анодирование представляет собой электролитный процесс, который повышает окисление поверхностей, предотвращая коррозию благодаря образованию защитного слоя.



verniciato bianco .53



verniciato burro .58



verniciato argento .54



verniciato tortora .59



verniciato caffè .57



verniciato antracite .52



anodizzato .50

vetro

Vetro float temperato serigrafato e vetrificato a 700°C. Tempered Float glass, screen-printed and vitrified at 700°C. Verre float trempé sérigraphié et vitrifié à 700°C. Sicherheitsglas mit innenliegendem Dekorsiebdruck, verglast bei 700°.

Vidrio float, templado, serigrafiado y vetrificado a 700°C. Vidro float temperado, impresso e vitrificado a 700°C. Temperli, üstü baskılı ve 700° C vitrikiye edilmiş. Сериграфированное закаленное стекло float, производимое при 700°C.



BIANCO .00



ANTRACITE .02

laminato HPL sp. 12 mm

Laminato decorativo ad alta pressione, compatto, omogeneo, non poroso, ad alta densità.
Decorative high pressure laminate, solid, homogeneous, non-porous and with a high density.
Stratififié décoratif à haute pression, condensé, homogène, pas poreux, haute densité.
HPL-Laminat, beständig, homogen, hoch verdichtet.
Laminado decorado a alta presión, compacto, homogéneo, no poroso y de alta densidad.

Decorativo e laminado a alta pressão, sólido, homogéneo, não poroso e de grande densidade.
Dekoratif yüksek basınçlı laminat, masif, gözeneksiz ve yüksek yoğunluklu.
Декоративный ламинат высокого давления, компактный, однородный, непористый, с высокой плотностью.



BIANCO .301



GRIGIO .300



CEMENTO .305



TORTORA .310



LEGNO .311



CORTEN .312



CAFFÈ .302



ANTRACITE .303

laminato HPL Solid Core sp. 10 mm

Laminato decorativo ad alta pressione, compatto, omogeneo, non poroso, ad alta densità.
Decorative high pressure laminate, solid, homogeneous, non-porous and with a high density.
Stratififié décoratif à haute pression, condensé, homogène, pas poreux, haute densité.
HPL-Laminat, beständig, homogen, hoch verdichtet.
Laminado decorado a alta presión, compacto, homogéneo, no poroso y de alta densidad.

Decorativo e laminado a alta pressão, sólido, homogéneo, não poroso e de grande densidade.
Dekoratif yüksek basınçlı laminat, masif, gözeneksiz ve yüksek yoğunluklu.
Декоративный ламинат высокого давления, компактный, однородный, непористый, с высокой плотностью.



TOTAL WHITE .314

Fenix NTM®/Solid sp. 10 mm



NERO FENIX NTM® .313

werzalit-topalit®

Piano speciale protetto da laminato melamminico decorato, di facile pulizia, resistente alle macchie, al calore, alle intemperie.
Werzalit-topalit tops are protected by a special printed foil that is weather proof, easy to clean and resistant to marks and heat.
Plateau special protégé en laminé décoré, facile à nettoyer, résistant aux taches, à la chaleur et aux intempéries.
Spezialplatte, mit verzierten Melaminlaminat geschützt leicht zu reinigen, widerstandsfähig gegen Flecken, gegen Wärme und Witterungseinflüsse.

Tablero de mesa especial protegido por una lamina melaminica decorada, de facil limpieza, resistente a las manchas, el calor y la intemperie.
Os tempos werzalit estão protegidos com uma película especial à prova de água, fácil de limpar, resistente as manchas e ao calor.
Werzalit-topalit tablalar dış etkenlere karşı dayanıklı olan, temizliği kolay ve çizilmeye ve ısıya karşı dayanıklı özel bir tabakayla korunur.
Особая столешница, защищенная декорированным меламиновым ламинатом, который устойчив к пятнам, теплу и негативному воздействию окружающей среды.

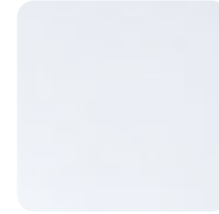

BIANCO .190

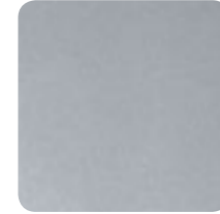

ARGENTO .197

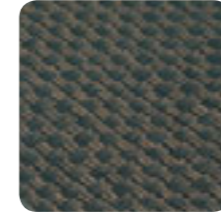

WICKER .198



impilabile stackable empilable stapelbar apilable empilhável istiflenebilir стекируемые



impilabile orizzontalmente stackable horizontally piètement encastrable horizontal stapelbar apilable horizontalmente empilhável horizontalmente yatay olarak istiflenebilir горизонтальная расстановка



pieghevole folding pliant klappbar plegable dobrável katlanabilir складывающийся



reclinabile reclining dossier réglable verstellbare Rückenlehne reclinable reclinável sırt pozisyonlu откидной

Tutte le sedute sono dotate di piedini antiscivolo. All chairs are equipped with non-slip rubber feet. Tous les sièges sont équipés avec embouts anti-dérapants.
Alle Stühle sind mit rutschfesten Fußkappen ausgestattet. Todos los asientos están equipados con tacos antideslizantes. Todos os assentos estão equipados com pés anti-derrapantes.
Bütün sandalyeler kaymaz ayaklıdır. Ножки всех стульев оснащены противоскользящей резиновой подложкой.

Sui colori scuri, ombre ed altri difetti minori sono più evidenti rispetto ai colori chiari e sono da ritenersi standard. On dark colors, shadows and other minor faults are more evident than on lighter colors and are therefore standard. Sur les couleurs sombres, les ombres et les autres petits défauts sont plus marqués que sur les couleurs claires et sont tout à fait standards. Auf dunklen Farben sind Schatten und andere kleinere Mängel sichtbar als auf hellen Farben und sind daher als Standard zu betrachten. Las sombras y demás defectos menores son más evidentes sobre los colores oscuros respecto a los colores claros y tienen que considerarse como estándares. Em cores escuras, sombras e outros defeitos menores são mais evidentes do que em cores claras e devem ser considerados standard. Koyu renkler üzerinde, gölgeler ve diğer küçük defolar açık renkler üzerinde olduklarından daha belirginleşmekte ve bu nedenle normal olarak değerlendirilmelidirler. По сравнению со светлыми цветами на темных цветах тени и другие небольшие дефекты более заметны и должны считаться нормой.

Il peso (kg), le misure (cm) e i colori riportati sono indicativi. La NARDI si riserva il diritto di apportare modifiche o varianti senza preavviso. Tutti i modelli sono depositati. Weights (kg), dimensions (cm) and colors are indicative only. NARDI reserves the right to make changes or variations without notice. All models are patented. Le poids (kg), les dimensions (cm) et les coloris indiqués sont fournis purement à titre indicatif. La Firme NARDI se réserve le droit d'apporter toute modification ou variation sans aucun préavis. Tous les modèles sont déposés. Alle Farb-, Maß- (cm) und Gewichtsangaben (kg) sind nicht als fest bindend anzusehen Firma NARDI behält sich das Recht von Änderungen Alle Modelle sind gesetzlich geschützt. El peso (kg), las medidas (cm) y los colores detallados, son indicativos. La firma NARDI se reserva el derecho de modificaciones o variaciones sin previo aviso. Todos los modelos llevan nuestra marca. O peso (kg), as medidas (cm) e as cores indicadas, são indicativos. A NARDI reservase o direito de aportar modificações ou variações sem préaviso. Todos os modelos estão depositados. Ağırılık (Kg), boyutlar (cm) ve renkler gösterme amaçlıdır. NARDI'nin önceden bildirmeden değişiklik yapma hakkı vardır. Bütün modeller patentlidir. Приведенный вес (кг), размеры (см) и цвета являются ориентировочными. Компания NARDI оставляет за собой права вносить изменения и вариации без предварительного предупреждения. Все модели зарегистрированы.

NARDI s.p.a.
Chiampo (VI) Italy
tel. +39 0444 422100
info@nardioutdoor.com
www.nardioutdoor.com

